



CC 6800
Crawler Crane
1250t capacity

Datasheet metric



CC 6800

WORKS FOR YOU.™

Page · Seite · Page · Pagina · Página · Página · Страница:

Specifications · Technische Daten · Caractéristiques · Dati tecnici · Datos técnicos · Especificações · Технические характеристики	5
Superlift configurations · Superlift-Konfigurationen · Combinaisons Superlift · Configurazioni Superlift · Configuraciones Superlift · Configurações do Superlift · Варианты конфигурации суперлифт	10
Specifications · Technische Daten · Caractéristiques · Dati tecnici · Datos técnicos · Especificações · Технические характеристики	11
Erection / lowering · Aufrichten / Ablegen · Monter / déposer · Montaggio / calata · Erección / descenso · Levantamento / descida · Подъем/опускание	13
Boom combinations · Ausleger-Kombinationen · Combinaisons de flèche · Combinazioni braccio · Combinaciones de pluma · Combinações de lanças · Комбинации стрелы	14

Main boom · Hauptausleger · Flèche principale · Braccio base · Pluma principal · Lança principal · Главная стрела (SH, SH/LH, LH)	16
Main boom with SL · Hauptausleger mit SL · Flèche principale avec SL · Braccio base con SL · Pluma principal con SL · Lança principal com SL · Главная стрела с SL (SSL, SSL/LSL, SSL/LSL S1)	20













Fixed fly jib with SL · Starrer Hilfsausleger mit SL · Fléchette fixe avec SL · Falcone fisso con SL · Plumín fijo con SL · Lança auxiliar fixa com SL · Неподвижная стрела с изменяемым вылетом с SL (SSL/LSL S1+LF)	24
---	----

Luffing fly jib · Wippbarer Hilfsausleger · Fléchette à volée variable · Falcone a volata variabile · Plumín abatible · Jib de lance variável · Стрела с изменяемым углом вылета и гуськом (SW)	38
Luffing fly jib with SL · Wippbarer Hilfsausleger mit SL · Fléchette à volée variable avec SL · Falcone a volata variabile con SL · Plumín abatible con SL · Jib de lance variável com SL · Стрела с изменяемым углом вылета и гуськом с SL (SWSL / SFSL 15°)	43

Fixed fly jib with SL · Starrer Hilfsausleger mit SL · Fléchette fixe avec SL · Falcone fisso con SL · Plumín fijo con SL · Lança auxiliar fixa com SL · Неподвижная стрела с изменяемым вылетом с SL (SFVL / LFVL)	68
---	----

Technical description · Technische Beschreibung · Descriptif technique · Descrizione tecnica · Descripción técnica · Descrição técnica · Техническое описание	70
--	----

Zeichenerklärung · Légende · Leggenda · Leyenda · Legenda · Условные Обозначения

	Track · Spur · Voie · Cingolo · Orugas · Esteira · Колея		
	Counterweight + central ballast (ZB) · Gegen- gewicht + Zentralballast (ZB) · Contrepoids + lest central (ZB) · Contrappeso + zavorra centrale (ZB) · Contrapeso + lastre central (ZB) · Contrapeso + lastro central (ZB) · Противовес + центральный балласт (ZB)		
	Superlift counterweight · Superlift-Gegengewicht · Contrepoids Superlift · Contrappeso Superlift · Contrapeso Superlift · Contrapeso do Superlift · Противовес суперлифт		
	Superlift radius · Superlift-Radius · Rayon Superlift · Sbraccio Superlift · Radio de Superlift · Raio do Superlift · Радиус для оборудования суперлифт		
	Possible load of hook block · Mögliche Traglast Unterflasche · Charge possible de crochet-moufle · Portata possibile di bozzello · Carga permitida de gancho · Carga possível do moitão · Допустимая нагрузка на крюкблок		
	Weight of hook block · Gewicht Unterflasche · Poids de crochet-moufle · Peso di bozzello · Peso de gancho · Peso do moitão · Вес крюкблока		
	Load radius · Lastradius · Portée · Raggio di lavoro · Radio de trabajo · Raio de operação · Рабочий радиус		
	Main boom · Hauptausleger · Flèche principale · Braccio principale · Pluma principal · Lança principal · Главная стрела		
	Fly jib · Hilfsausleger · Fléchette · Falcone · Plumín · Lança auxiliar · Стрела с изменяемым вылетом		
	Main boom angle · Hauptauslegerwinkel · Jarret de flèche principale · Inclinazione braccio base · Ángulo de pluma principal · Ângulo da lança principal · Угол наклона главной стрелы		
	Fly jib angle · Hilfsauslegerwinkel · Jarret de fléchette · Inclinazione falcone · Ángulo de plumín · Ángulo da lança auxiliar · Угол наклона стрелы с изменяемым вылетом		
	Wind speed in m/s (meter per second) · Windge- schwindigkeit in m/s · Vitesse du vent en m/s · Velocità del vento in m/s (metri al secondo) · Velocidad del viento en m/s · Velocidade do vento em m/s (metros por segundo) · Скорость ветра в м/сек		
		„D“	
		S:	heavy · schwer · lourde · pesante · pesado · pesada · сильный
		L:	light · leicht · léger · leggera · ligero · leve · слабый
		H:	Main boom · Hauptausleger · Flèche principale · Braccio principale · Pluma principal · Lança principal · Главная стрела
		W:	Luffing fly jib · Wippbarer Hilfsausleger · Fléchette à volée variable · Falcone a volata variabile · Plumín abatible · Jib de lance variável · Стрела с изменяемым углом вылета и гуськом
		F:	Fixed fly jib · Starrer Hilfsausleger · Fléchette fixe · Falcone fisso · Plumín fijo · Lança auxiliar fixa · Неподвижная стрела с изменяемым вылетом
		SL:	Superlift · Superlift · Levage supplémentaire · Superlift · Superlift · Kit Superlift · Суперлифт (система для увеличения грузоподъемности)
		V:	Vessellift · Vessellift · Vessellift · Vessellift · Vessellift · Içamento de embarcação · Подъем судов
		SGL:	Heavy base length · Schwere Grundlänge · Longueur de base lourde · Lunghezza carro in versione pesante · Longitud de base pesada · Comprimento da base pesada · Длина тяжелой базы

- ▶ Excellent lifting capacities throughout all working ranges, especially with luffing fly jib
 - ▶ Max. load moment 13840 tm
 - ▶ Two redundant operating drivelines
 - ▶ Highly simplified assembly processes for short rigging times
 - ▶ Hydraulic quick-connection
 - ▶ Innovative IC-1 crane control system with touchscreen
 - ▶ Superlift radius infinitely variable during operation from 15-24 m
 - ▶ Variable offset of main boom with SW and SWSL configurations
 - ▶ Powerful Quadro-Drive as standard
 - ▶ Hydraulic assisted pinning of boom sections is standard
 - ▶ PC outrigger optional
- ▶ Hervorragende Tragfähigkeiten über alle Arbeitsbereiche, insbesondere am wippbaren Hilfsausleger
 - ▶ Max. Lastmoment 13840 mt
 - ▶ Zwei redundant arbeitende Antriebseinheiten
 - ▶ Enorm vereinfachte Montage und kürzeste Rüstzeiten
 - ▶ Hydraulische Schnellverbindung
 - ▶ Innovative Kransteuerung IC-1 mit Touchscreen
 - ▶ Variabler Superlift-Radius verstellbar von 15-24 m
 - ▶ Variable Vorneigung Hauptausleger für SW und SWSL
 - ▶ Leistungsstarker Quadro-Antrieb serienmäßig
 - ▶ Serienmäßig hydraulisch verbolzbare Auslegerteile
 - ▶ Optionale PC-Abstützung
- ▶ Excellentes capacités de levage dans tous les domaines de travail particulièrement avec volée variable
 - ▶ Couple de charge max. 13840 tm
 - ▶ Deux unités de propulsion avec redondance intégrée
 - ▶ Assemblages considérablement simplifiés et temps de montage réduit
 - ▶ Connexion rapide hydraulique entre châssis et partie tournante
 - ▶ Nouveau système de contrôle IC-1 avec écran tactile
 - ▶ Rayon du Superlift variable 15-24 m
 - ▶ Flèche principale inclinable pour SW et SWSL
 - ▶ Puissant quadro en série
 - ▶ Boulonnement hydraulique des intercalaires de flèche en série
 - ▶ Base de calage variante PC en option
- ▶ Eccellenti capacità di sollevamento a tutte le portate di lavoro, in particolare con falcone a volata variabile
 - ▶ Momento di carico massimo 13840
 - ▶ Due trasmissioni operative per assicurare la ridondanza
 - ▶ Processo di montaggio altamente semplificato per abbreviare i tempi di attrezzamento
 - ▶ Attacchi rapidi idraulici
 - ▶ Innovativo sistema di controllo della gru IC-1, con display touch-screen
 - ▶ Sbraccio Superlift con regolazione continua durante il funzionamento da 15 a 24 m
 - ▶ Inclinazione variabile del braccio con configurazioni SW e SWSL
 - ▶ Potente Quadro Drive di serie
 - ▶ Fissaggio degli elementi del braccio con servocomando idraulico di serie
 - ▶ Stabilizzatori piedistallo gru opzionali
- ▶ Excelentes capacidades de elevación en todos los rangos de trabajo, especialmente con plumin abatible
 - ▶ Momento de carga máx. 13840 tm
 - ▶ Dos líneas de transmisión de operación redundante
 - ▶ Proceso de montaje extremadamente simplificado para cortos tiempos de montaje
 - ▶ Conexión hidráulica rápida
 - ▶ Innovador control de grúa IC-1 con pantalla táctil
 - ▶ Radio de Superlift en progresión continua durante la operación de 15 a 24 m.
 - ▶ Angulamiento variable de la pluma principal con configuraciones SW y SWSL
 - ▶ Potente transmisión Quadro de serie
 - ▶ Fijación de tramos de pluma por pernos asistidos hidráulicamente de serie
 - ▶ Estabilizador PC opcional
- ▶ Excelentes capacidades de içamento em todas as faixas de trabalho, especialmente com lança auxiliar articulada
 - ▶ Momento de carga máx. 13840 toneladas
 - ▶ Dois sistemas de tração redundantes em operação
 - ▶ Processos de montagem bastante simplificados reduzem os tempos de instalação
 - ▶ Conexão hidráulica de engate rápido
 - ▶ Inovador sistema IC-1 de controle do guindaste com tela de toque
 - ▶ Raio do Superlift infinitamente variável entre 15 e 24 m durante a operação
 - ▶ Inclinação variável da lança principal com configurações SW e SWSL
 - ▶ Poderosa tração quádrupla como item de série
 - ▶ A pinagem hidráulica assistida das seções da lança é característica de série.
 - ▶ Estabilizador opcional para PC
- ▶ Отличная грузоподъемность во всех диапазонах, особенно со стрелой с изменяемым вылетом
 - ▶ Макс. момент нагрузки 13840 мт
 - ▶ Две рабочие трансмиссии, одна всегда резервная
 - ▶ Значительно упрощенный процесс сборки, обеспечивающий быстроту установки
 - ▶ Быстроразъемное гидравлическое соединение
 - ▶ Инновационная система управления краном IC-1 с сенсорным экраном
 - ▶ Бесступенчатая регулировка радиуса суперлифта в процессе подъема в диапазоне 15-24 м.
 - ▶ Плавно изменяемый угол смещения главной стрелы в конфигурациях с SW и SWSL
 - ▶ Мощный квадропривод в стандартной комплектации
 - ▶ Гидравлическая система соединения штифтами секций стрелы входит в стандартную комплектацию
 - ▶ Выдвижные опоры для сборки в версии пьедестального крана (опция)

Technische Daten · Caractéristiques · Dati tecnici · Datos técnicos · Especificações · Технические характеристики

Working speeds (infinitely variable) · Arbeitsgeschwindigkeiten (stufenlos regelbar) · Vitesses de travail (réglables sans paliers) · Rapporti di lavoro (a regolazione continua) · Velocidades de trabajo (progresión continua) · Velocidades de trabalho (infinitamente variáveis) · Рабочие скорости (с бесступенчатой регулировкой)

Mechanism Antrieb Mécanisme Funzioni Mecanismos Mecanismo Механизм	Rope ø Seil-ø ø du câble ø fune ø cable Diâm. cabo Диаметр троса	Speeds ¹⁾ Geschwindigkeiten ¹⁾ Vitesses ¹⁾ Rapporti ¹⁾ Velocidades ¹⁾ Velocidades ¹⁾ Скорости ¹⁾	Single line pull Seilzug je Strang Effort sur brin simple Tiro fune singolo Tracción de cable simple Tração de linha simples Тяговое усилие на одиночном тросе	Length of hoist rope Länge des Hubseils Longueur du câble de levage Lunghezza della fune dell'argano Long. de cable de cabrestante Compr. do cabo do guincho Длина троса
Hoist I+II · Hubwerk I+II · Treuil de levage I+II · Agano I+II · Cabrestante I+II · Guincho I+II · подъем I+II	(H1+H2) 32 mm	max. 110 m/min	230 kN	1240 m
Hoist III · Hubwerk III · Treuil de levage III · Agano III · Cabrestante III · Guincho III · подъем III	(H3) 32 mm	max. 100 m/min	230 kN	700 m
Boom derricking · Wippwerk Hauptausleger · Variation de flèche · Inclinazione del braccio · Descenso de pluma · Inclinação da lança · Подъем стрелы деррик-краном	(W2) 32 mm	max. 110 m/min		
Boom hoist · Einziehwerk · Relevage de flèche · Argano del braccio · Cabrestante de pluma · Guincho da lança · Подъем стрелы	(E) 32 mm	max. 50 m/min		
Jib luffing · Wippwerk Hilfs- ausleger · Variation de volée · Sollevamento del braccio · Abatimiento de plumin · Inclinação da lança auxiliar · Изменение вылета стрелы	(W1) 32 mm	max. 105 m/min		
Slewing (rpm) · Drehwerk (U/min) Orientation (tr/mn) · Rotazione (rpm) · Unidad de giro (rpm) · Giro (rpm) · Поворот (rpm)		1,2		

¹⁾ top layer · oberste Lage · couches supérieure · avvolgimento superiore · capa superior · camada superior · верхний слой

Carrier performance · Fahrleistungen · Performances du porteur · Prestazioni del carro · Rendimiento del vehículo · Desempenho do veículo · Общие характеристики шасси

Travel speed · Fahrgeschwindigkeit · Vitesses de translation · Velocità di marcia · Velocidad de desplazamiento · Velocidade de marcha · Скорость движения	max. 1,1 km/h
---	---------------

SPECIFICATIONS

CC 6800

Technische Daten · Caractéristiques · Dati tecnici · Datos técnicos · Especificações · Технические характеристики

Hook block system · Unterflaschensystem · Système de crochet-moufle · Sistema per bozzello · Sistema de bloque de gancho · Sistema de moitão · Система крюкоблока

Type Typ Type Tipo Tipo Tipo Тип	Possible load Mögliche Traglast Charge possible Portata possibile Carga permitida Carga possível Допустимая нагрузка	Number of sheaves Anzahl der Rollen Nombre de poulies Numero di pulegge Total de poleas Número de polias Количество шкивов	Number of lines Strangzahl Nombre de brins No max avvolgim. Reenvios máx. Número de cabos Кратность троса	Weight Gewicht Poids Peso Peso Peso Вес	„D“
2 x 625	1250 t	2 x 15	2 x 31	29 000 kg	7,90 m
	630 t	2 x 7	2 x 15	19 000 kg	5,90 m
	630 t	15	31	19 000 kg	5,90 m
	330 t	7	15	9 000 kg	5,90 m
1000	1000 t	2 x 11	2 x 23	18 000 kg	6,70 m
	500 t	2 x 5	2 x 11	11 000 kg	7,20 m (6,50 m*)
	500 t	11	23	8 000 kg	7,20 m (6,50 m*)
	250 t	5	11	7 600 kg (5 800 kg*)	7,20 m (6,00 m*)
800	800 t	2 x 11	2 x 19	16 000 kg	6,50 m
	500 t	2 x 5	2 x 11	11 000 kg	7,20 m (6,50 m*)
	500 t	11	23	8 000 kg	7,20 m (6,50 m*)
	250 t	5	11	7 600 kg (5 800 kg*)	7,20 m (6,00 m*)

* with optional equipment 500 t hook · mit optionalem 500 t Haken · avec équipement optionnel: crochet de 500 t · con gancio opzionale da 500 t · con equipamiento opcional, gancho 500 t · com gancho de 500 t como equipamento opcional · с опциональным крюком 500 т

Hook block · Unterflasche · Crochet-moufle · Bozzello · Bloque de gancho · Moitão · Крюкоблок

Type Typ Type Tipo Tipo Tipo Тип	Possible load Mögliche Traglast Charge possible Portata possibile Carga permitida Carga possível Допустимая нагрузка	Number of sheaves Anzahl der Rollen Nombre de poulies Numero di pulegge Total de poleas Número de polias Количество шкивов	Number of lines Strangzahl Nombre de brins No max avvolgim. Reenvios máx. Número de cabos Кратность троса	Weight Gewicht Poids Peso Peso Peso Вес	„D“
70	70 t	1	3	3 900 kg	4,80 m
25	23 t	Single line hook / Hakengehänge / Boulet / Gancio singolo / Gancho simple / Gancho para linha singela / Крюк на одиночном тросе	1	1 500 kg	4,00 m

SPECIFICATIONS

CC 6800

Technische Daten · Caractéristiques · Dati tecnici ·
Datos técnicos · Especificações · Технические характеристики

Basic crane dimensions · Hauptabmessungen · Dimensions de la grue de base · Dimensioni di base della gru ·
Dimensiones básicas de la grúa · Dimensões do guindaste básico · Базовые габариты крана

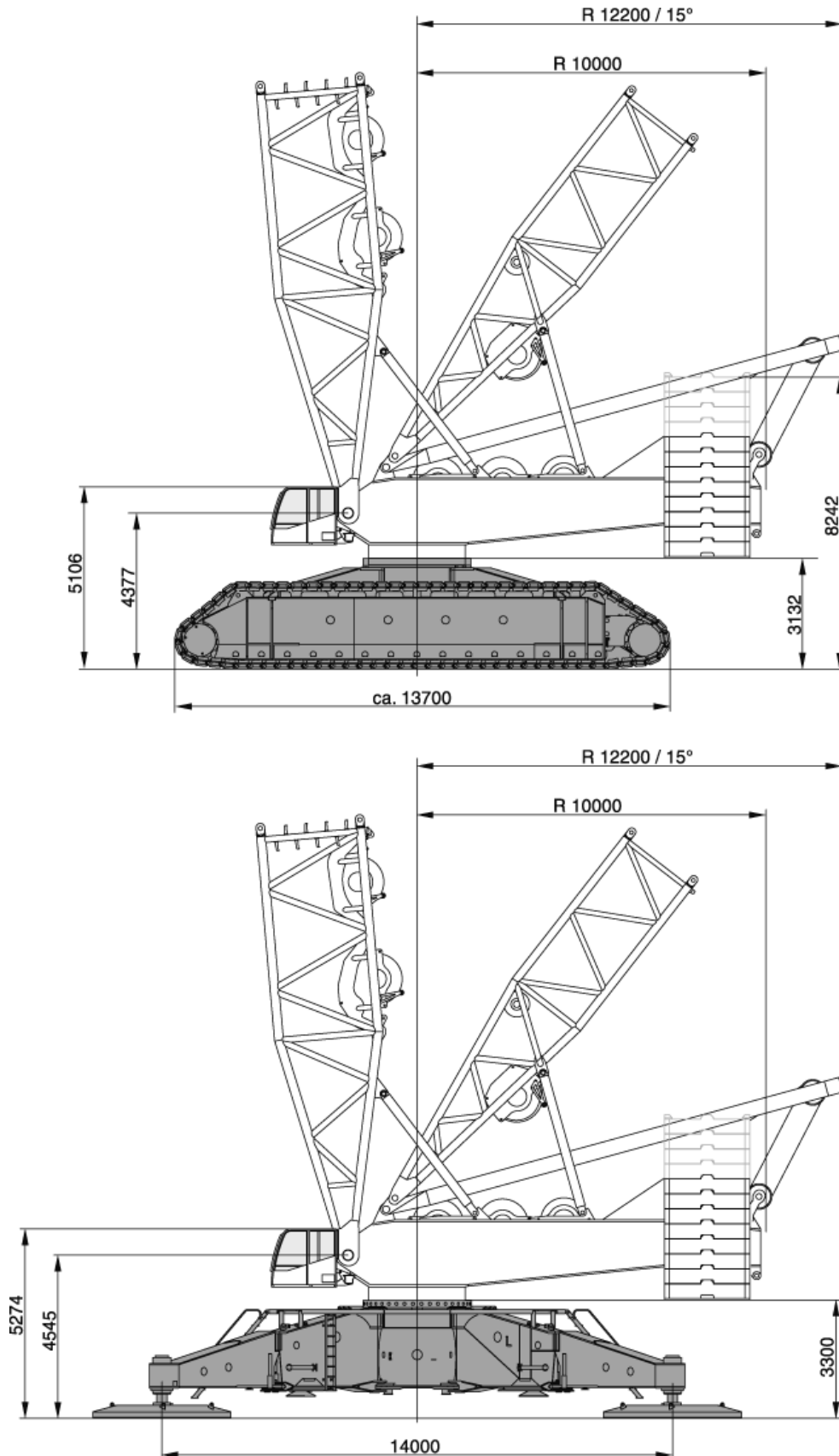

SPECIFICATIONS

CC 6800

Technische Daten · Caractéristiques · Dati tecnici ·
Datos técnicos · Especificações · Технические характеристики

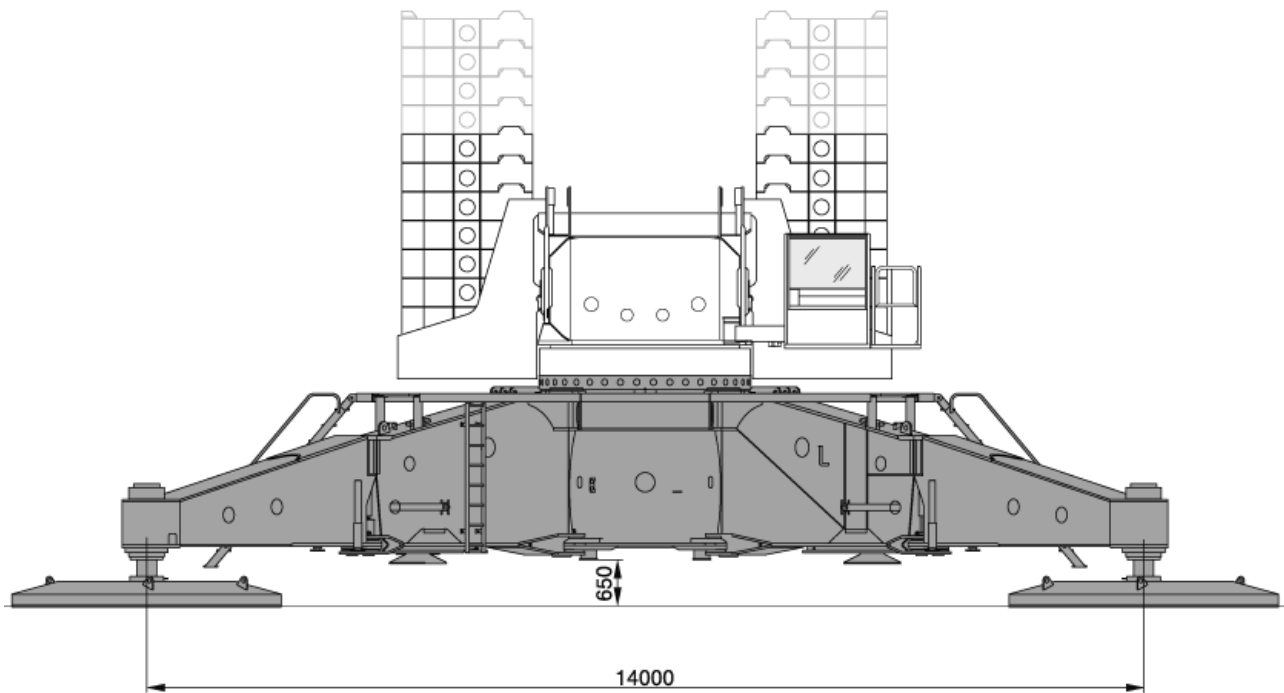
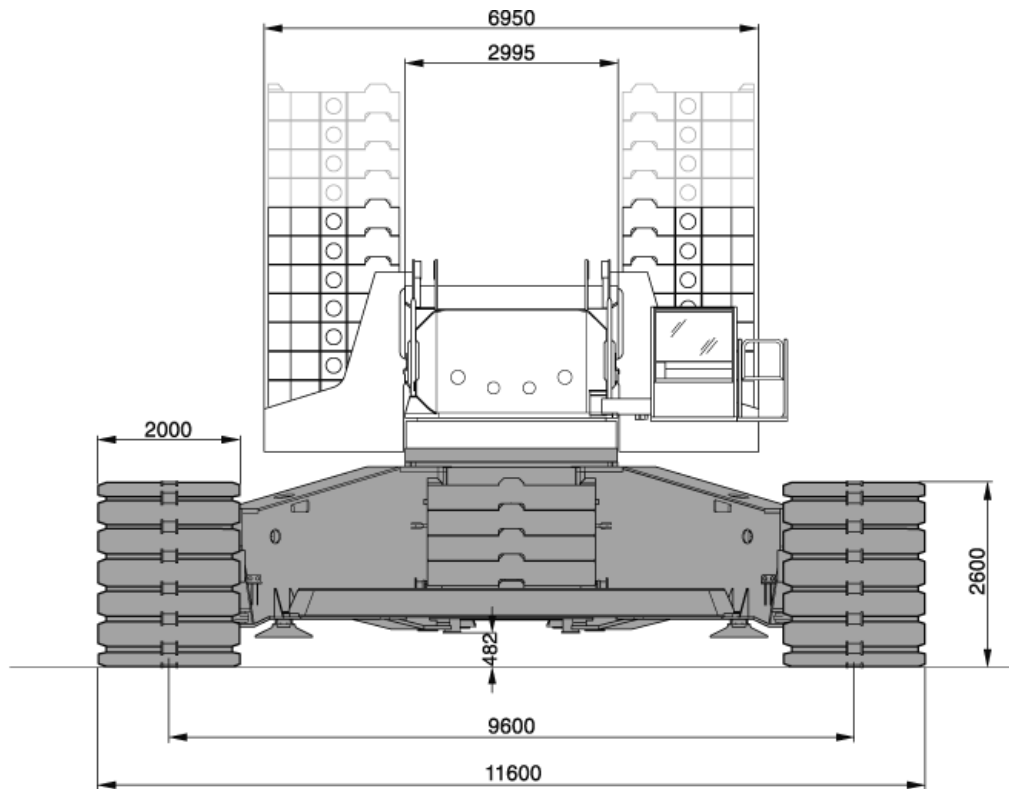

SPECIFICATIONS

CC 6800

Technische Daten · Caractéristiques · Dati tecnici ·
Datos técnicos · Especificações · Технические характеристики

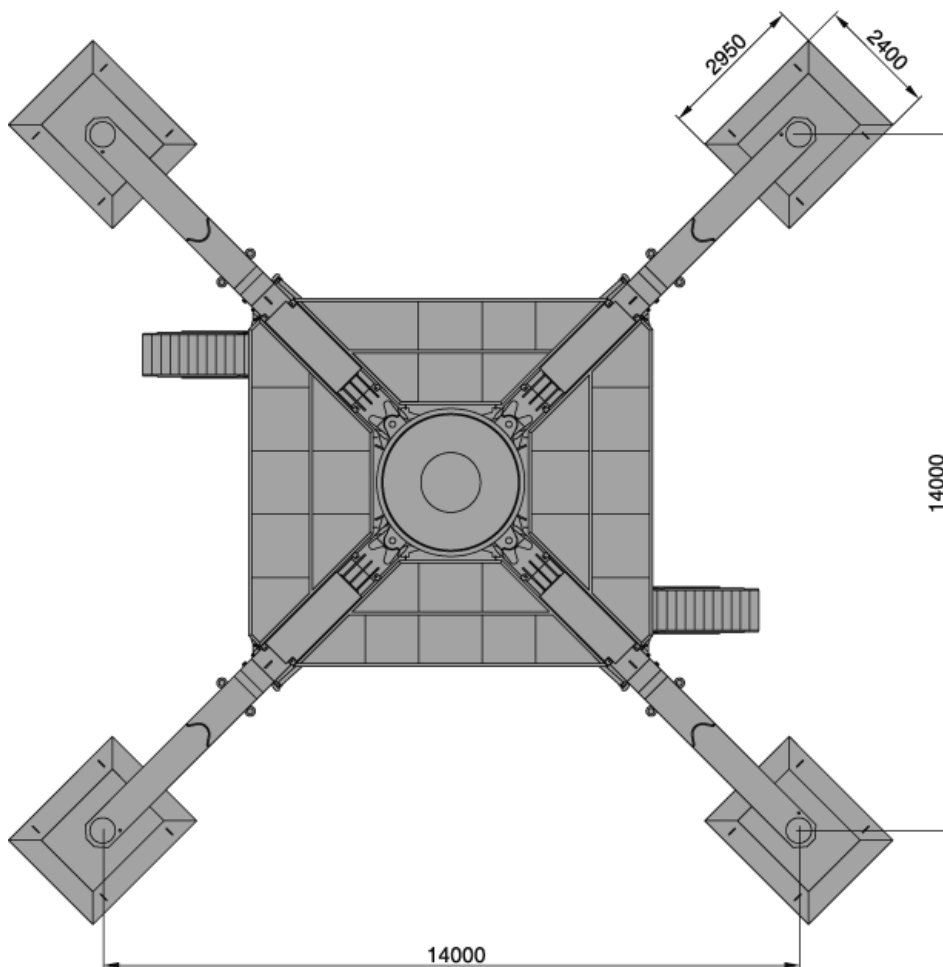
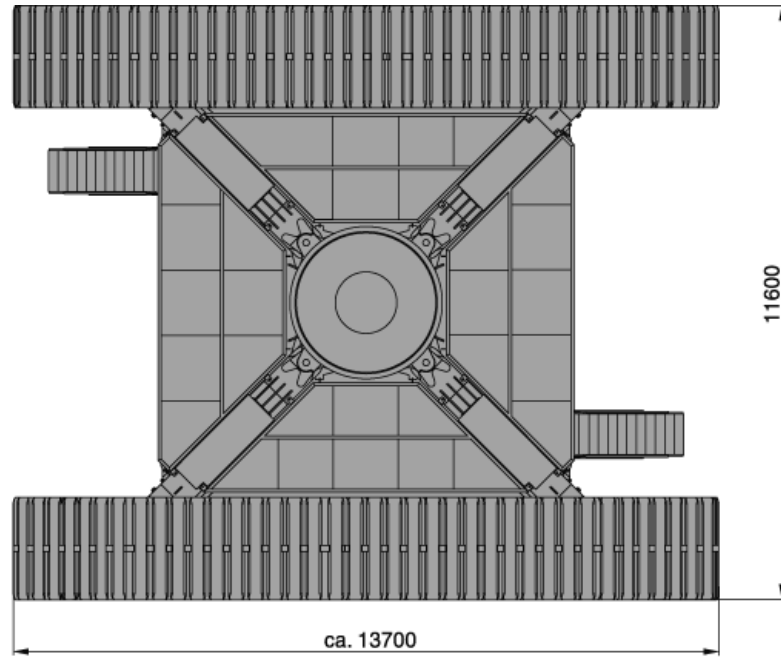

SUPERLIFT CONFIGURATIONS

CC 6800

Superlift-Konfigurationen · Combinaisons Superlift · Configurazioni Superlift · Configuraciones Superlift · Configurações do Superlift · Варианты конфигурации суперлифт

Standard Superlift attachment · Serienmäßige Superlifteinrichtung · Superlift de série · Sistema Superlift di serie · Accesorio Superlift estándar · Acessório Superlift padrão · Стандартный комплект оборудования суперлифт

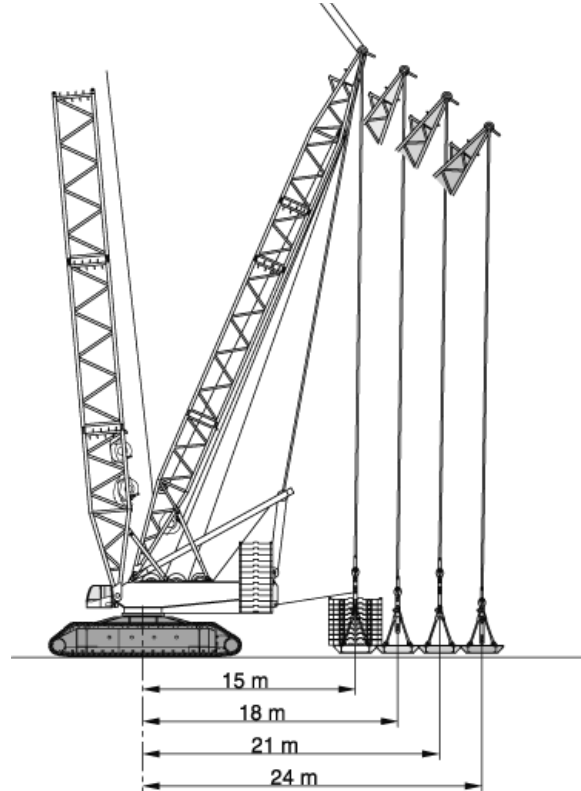

Variable Superlift attachment · Variable Superlifteinrichtung · Superlift variable · Configurazione Superlift variabile · Accesorio Superlift variable · Acessório Superlift variável · Оборудование суперлифт с регулировкой по весу подъема

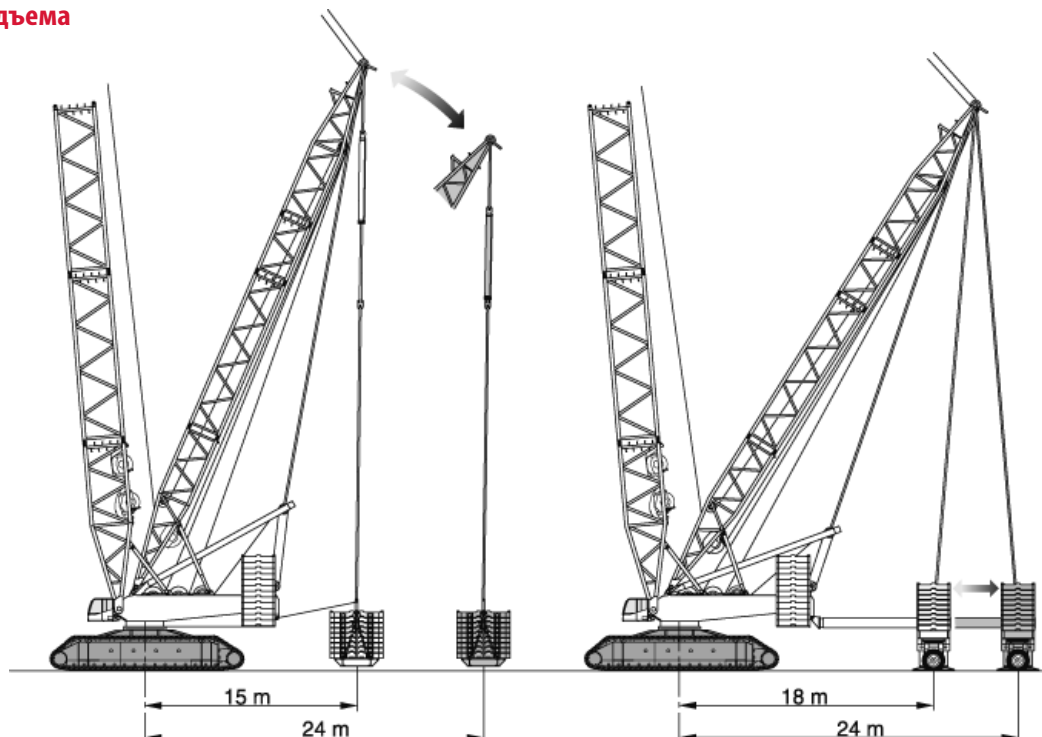

SPECIFICATIONS

CC 6800

Technische Daten · Caractéristiques · Dati tecnici · Datos técnicos · Especificações · Технические характеристики

Weights · Gewichte · Poids · Peso · Peso · Peso · Вес

Total weight incl. 170 t counterweight, 36 m boom and hook block Gesamtgewicht einschl. 170 t Gegengewicht, 36 m Hauptausleger und Unterflasche Poids avec 170 t de contrepoids, flèche de 36 m et crochet Peso totale incl. contrappeso 170 t, braccio 36 m e bozzello · Peso total incl. contrapeso de 170 t, pluma de 36 m y bloque de gancho · Peso total incl. Contrapeso de 170 t, lança de 36 m e moitão · Общий вес, включая противовес 170 т, стрелу длиной 36 м и крюкблок	560 t
Superstructure (with 3 winches, A-frame and quick-connection) Oberwagen (mit 3 Winden, A-Bock und Schnellverbindung) · Partie supérieure (avec 3 tambours, chevalet et connexion rapide) · Torretta (con 3 argani, cuspide e attacco rapido) · Superestructura (con 3 cabrestantes, caballete y conexión rápida) · Superestruturura (com 3 guinchos, suporte angular e engate rápido) · Надстройка (с 3 лебедками, А-образной рамой и системой быстроразъемных соединений)	99 t
Superstructure without winches and A-frame Oberwagen ohne Winden und A-Bock · Partie supérieure sans tambours et chevalet · Torretta senza argani e cuspide · Superestructura sin cabrestantes ni caballete · Superestruturura sem guinchos e suporte angular · Надстройка без лебедок и А-образной рамы	54 t
Carbody with jacks and quick-connection Mittelstück mit Abstützung und Schnellverbindung · Partie centrale avec appuis et connexion rapide · Carrozzeria con martinetti e attacco rapido · Cuerpo central con gatos y conexión rápida · Chassi com macacos e engate rápido · Корпус шасси с домкратами и системой быстроразъемных соединений	48 t
Crawlers with track shoes (2000 mm) Raupen mit Bodenplatten (2000 mm) · Chenilles avec patins (2000 mm) · Cingoli con pattini (2000 mm) · Orugas equipadas (2000 mm) · Esteiras com sapatas (2000 mm) · Гусеницы с башмаками (2000 мм)	70 t
Crawlers without track shoes Raupen ohne Bodenplatten · Chenilles sans patins · Cingoli senza pattini · Orugas no equipadas · Esteiras sem sapatas · Гусеницы без башмаков	38 t
Counterweight · Gegengewicht · Contrepoids · Contrappeso · Contrapeso · Contrapeso · Противовес	170 t

Counterweight · Gegengewicht · Contrepoids · Contrappeso · Contrapeso · Contrapeso · Противовес

Central ballast (ZB) · Zentralballast (ZB) · Lest central (ZB) ·
Zavorra centrale (ZB) · Lastre central (ZB) · Lastro central (ZB) ·
Центральный балласт (ZB)

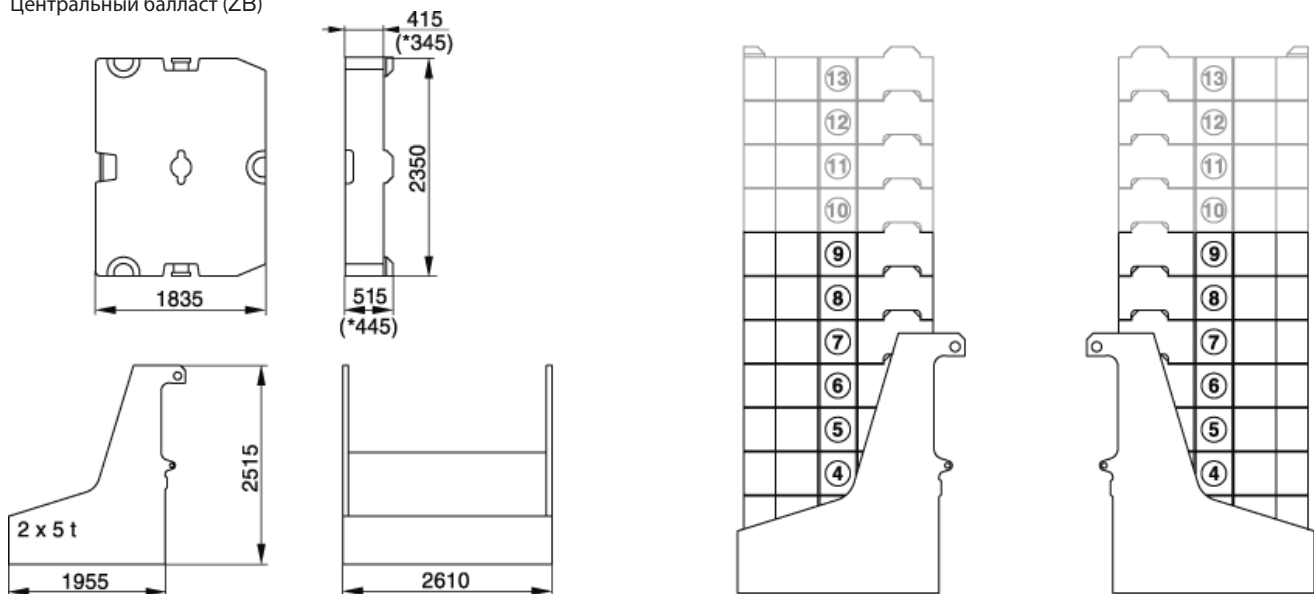

* Option · Option · En option · Opzione · Opcion · Opcional · Опция

SPECIFICATIONS

CC 6800

Technische Daten · Caractéristiques · Dati tecnici ·
Datos técnicos · Especificações · Технические характеристики

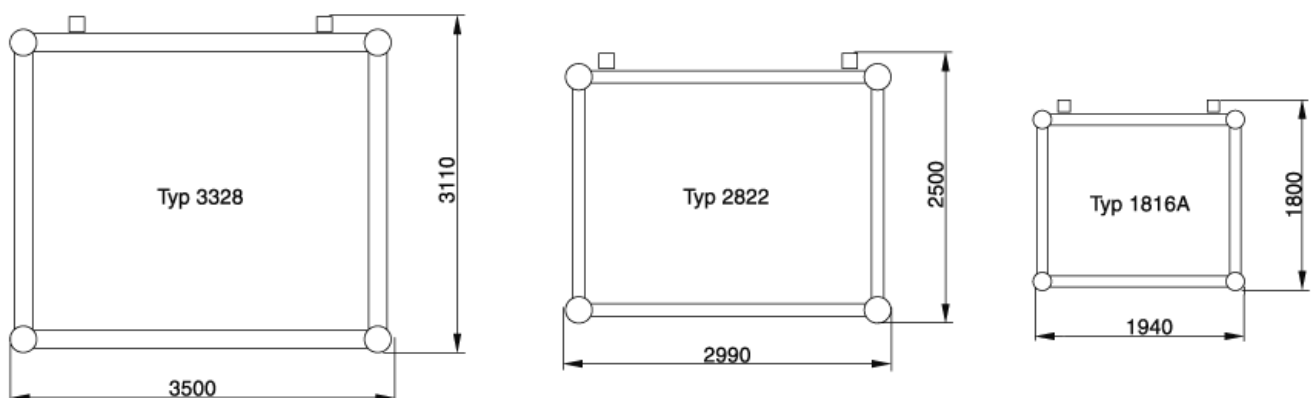
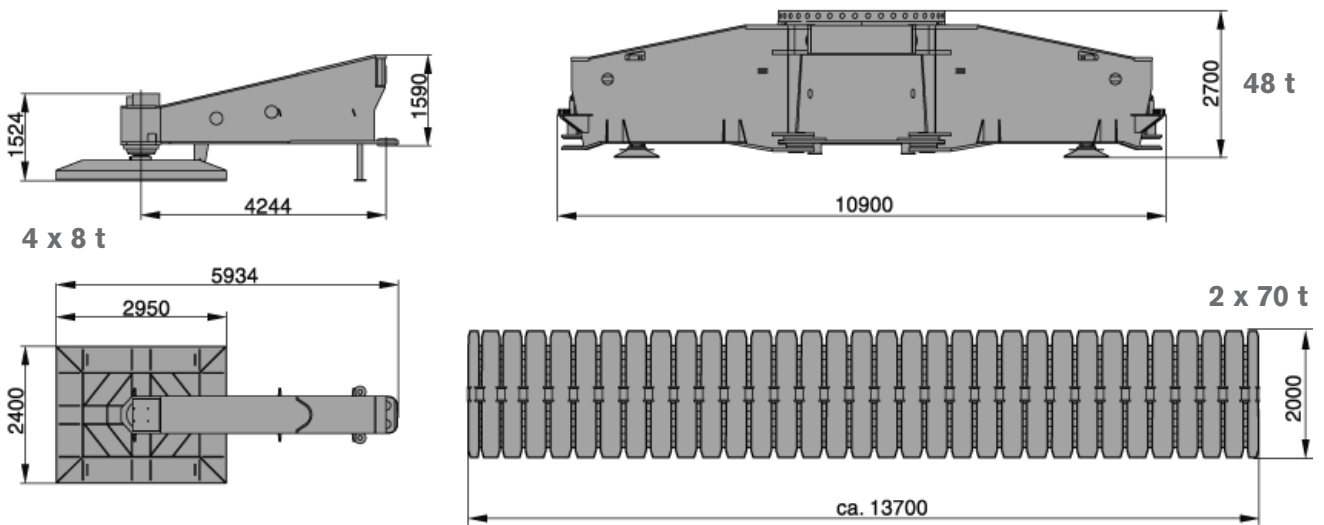
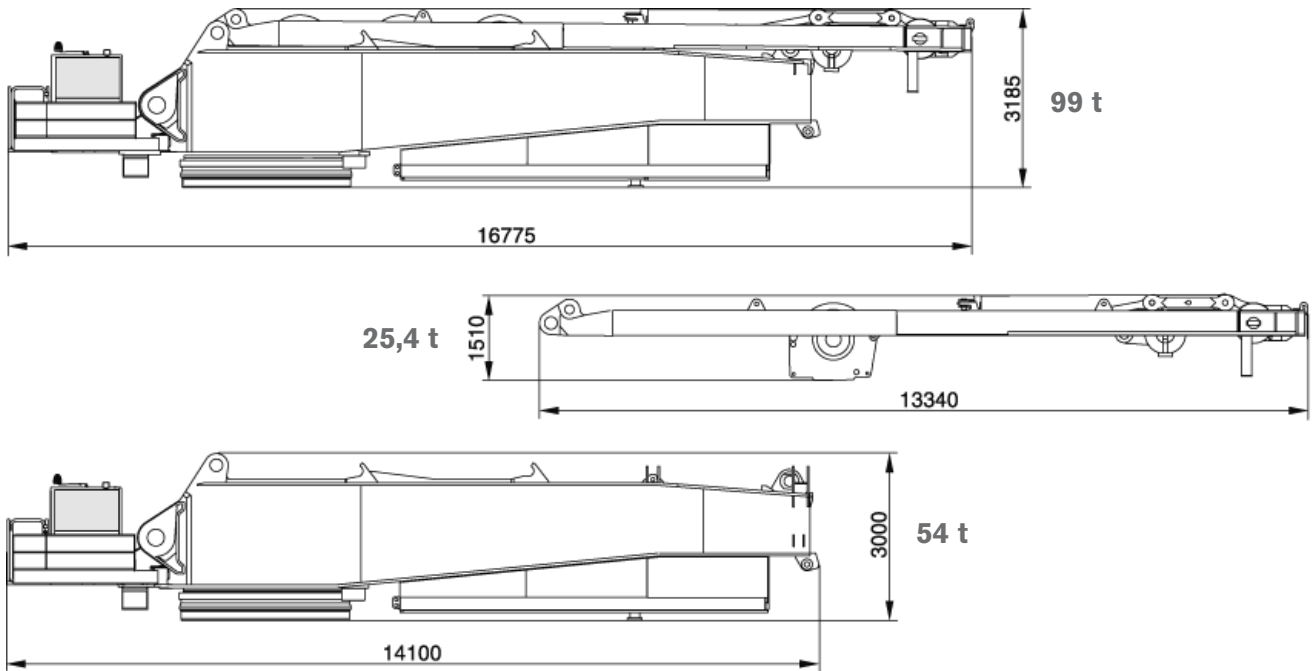

ERECTION / LOWERING

CC 6800

**Aufrichten / Ablegen · Montée / Placement · Montaggio / calata ·
Erección / descenso · Levantamento / descida · Подъем/опускание**

**Erection / lowering of the CC 6800 boom systems to the ground · Aufrichten / Ablegen der CC 6800 Ausleger-
systeme · Montée / placement sur sol des systèmes de flèche de la CC 6800 · Montaggio / calata dei
sistemi braccio CC 6800 a terra · Erección / descenso al terreno del sistema de pluma del CC 6800 ·
Levantamento / descida dos sistemas da lança do CC 6800 para o solo · Подъем/опускание системы стрелы
крана CC 6800 на землю**

☰ 170-250 t 0-80 t ZB		↔ 15-24 m														
Boom combination Auslegervariante Combinaison de flèche Combinazione braccio Combinación de pluma Combinação de lanças Комбинация стрелы	Fly jib (m) Hilfsausleger Fléchette Falcone Plumin Lança auxiliar Стрела с изменяемым вылетом	Main boom · Hauptausleger · Flèche principale · Braccio base · Pluma principal · Lança principal · Главная стрела														
		m	36	42	48	54	60	66	72	78	84	90	96	102	108	114
SH			X	X	X	X	X	X	X	[X]	[X]	[X]	[X]	-	-	-
SH/LH			-	-	X	X	X	X	X	X	X	[X]	[X]	[X]	[X]	-
LH			-	-	X	X	X	X	X	X	X	X	X	X	[X]	[X]
SW 87°	30		-	X	X	X	[X]	-	-	-	-	-	-	-	-	-
	36		-	X	X	X	[X]	-	-	-	-	-	-	-	-	-
	42		-	X	X	X	[X]	-	-	-	-	-	-	-	-	-
	48		-	X	X	X	[X]	-	-	-	-	-	-	-	-	-
	54		-	X	X	X	[X]	-	-	-	-	-	-	-	-	-
	60		-	X	X	[X]	[X]	-	-	-	-	-	-	-	-	-
	66		-	X	X	[X]	[X]	-	-	-	-	-	-	-	-	-
	72		-	X	X	[X]	-	-	-	-	-	-	-	-	-	-
	78		-	X	X	[X]	-	-	-	-	-	-	-	-	-	-
	84		-	X	X	[X]	-	-	-	-	-	-	-	-	-	-
90		-	X	X	[X]	-	-	-	-	-	-	-	-	-	-	
96		-	X	X	[X]	-	-	-	-	-	-	-	-	-	-	

X without assisting equipment · ohne Zusatzausrüstung · sans équipement aditionnel · senza attrezzatura di supporto ·
sin equipamiento de asistencia · sem equipamento auxiliar · без вспомогательного оборудования

[X] with additional side jack · mit seitlicher Zusatzabstützung · avec support latéral aditionnel · con martinetto laterale aggiuntivo ·
con gato lateral adicional · com macaco lateral adicional · с дополнительным боковым домкратом

All Superlift combinations can be erected or lowered to the ground without assisting equipment.

Alle Varianten mit Superlift können ohne Zusatzausrüstung aufgerichtet bzw. abgelegt werden.

Montée et dépose sur sol de toutes les combinaisons avec SL sans équipement aditionnel.

Tutte le combinazioni Superlift possono essere alzate o abbassate a terra senza attrezzatura di supporto.

Todas las combinaciones Superlift se pueden erigir o descender al terreno sin equipamiento de asistencia.

Todas as combinações de Superlift podem ser levantadas ou baixadas ao solo sem equipamentos auxiliares.

Оборудование суперлифт в любой конфигурации поднимается и опускается на землю без вспомогательного оборудования.

BOOM COMBINATIONS

CC 6800

Ausleger-Kombinationen · Combinaisons de flèche · Combinazioni braccio ·
Combinaciones de pluma · Combinações de lanças · Комбинации стрелы

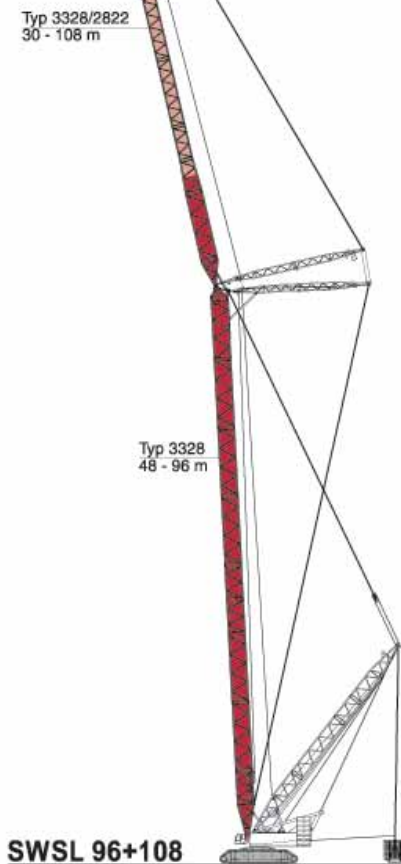
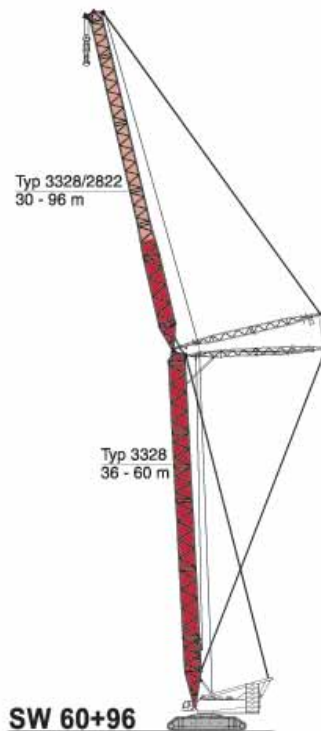
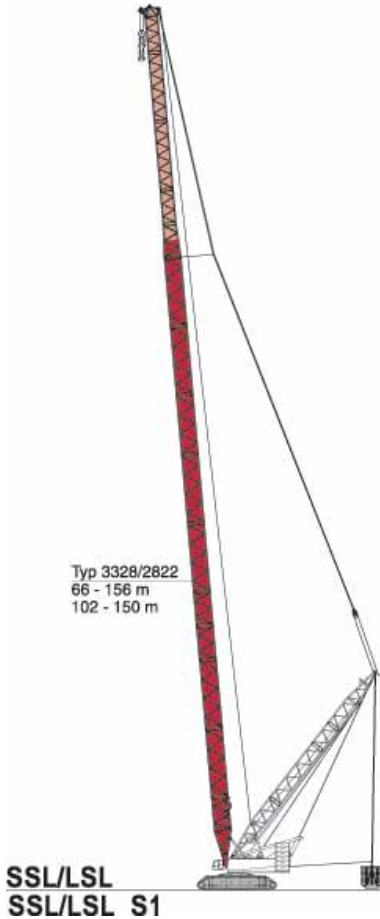
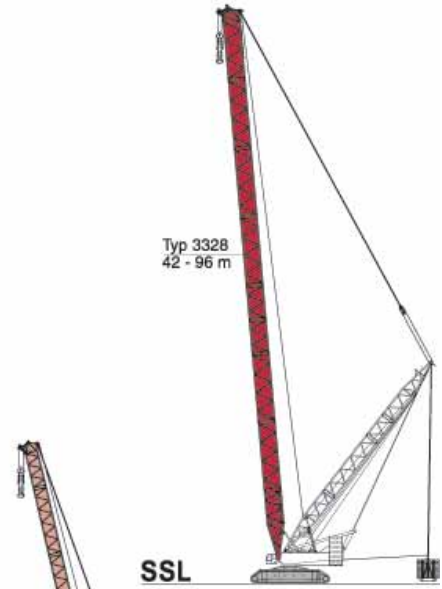
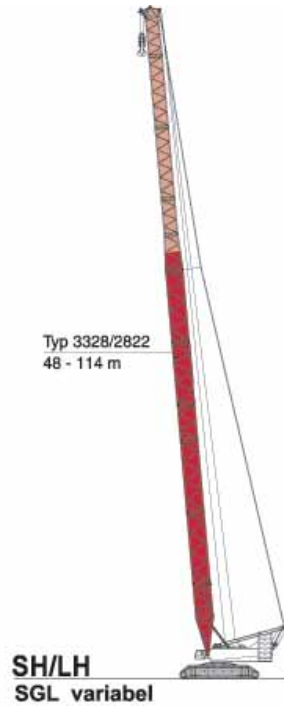
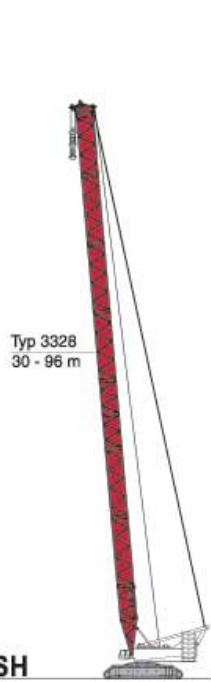

BOOM COMBINATIONS

CC 6800

**Ausleger-Kombinationen · Combinaisons de flèche · Combinazioni braccio ·
Combinaciones de pluma · Combinações de lanças · Комбинации стрелы**

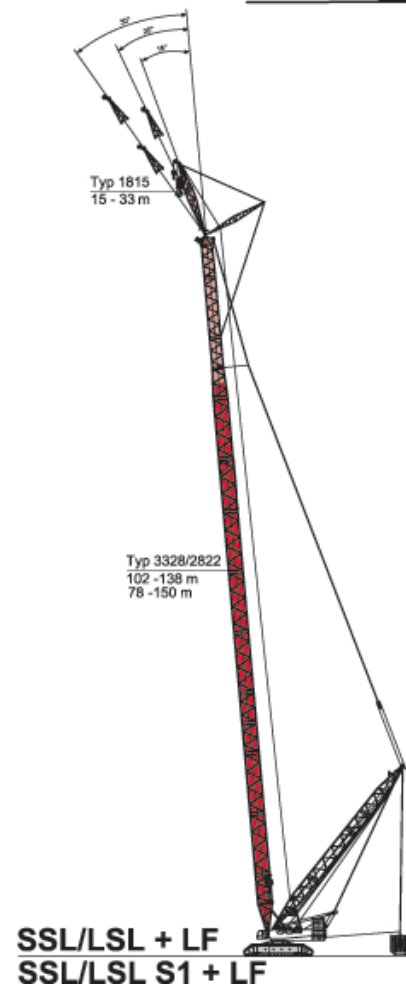
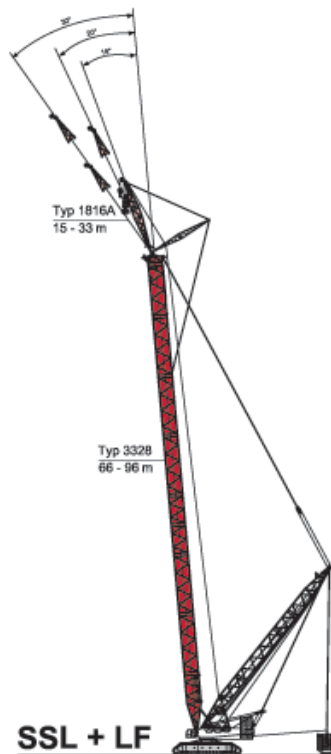
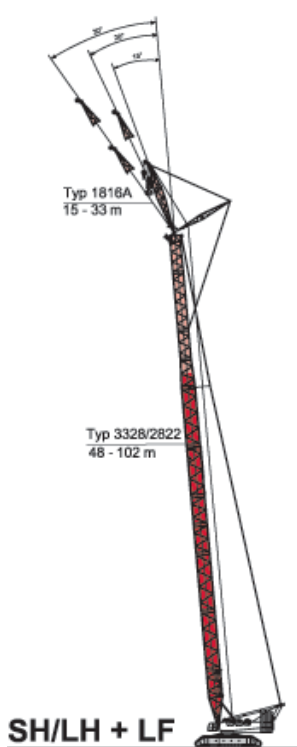
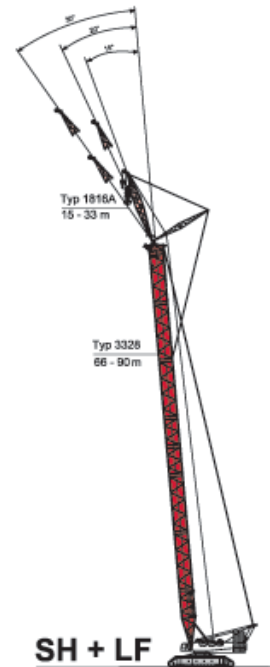
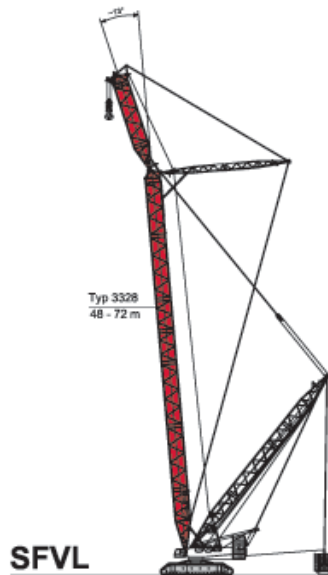
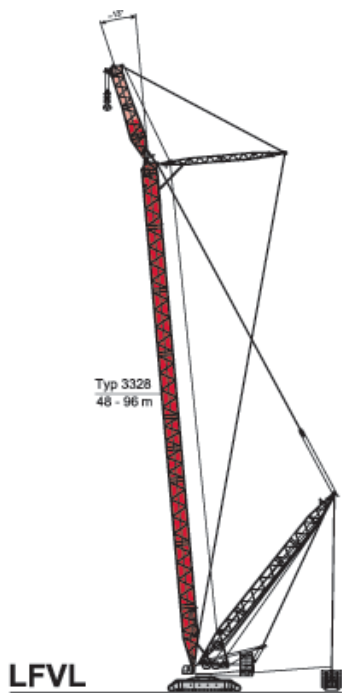

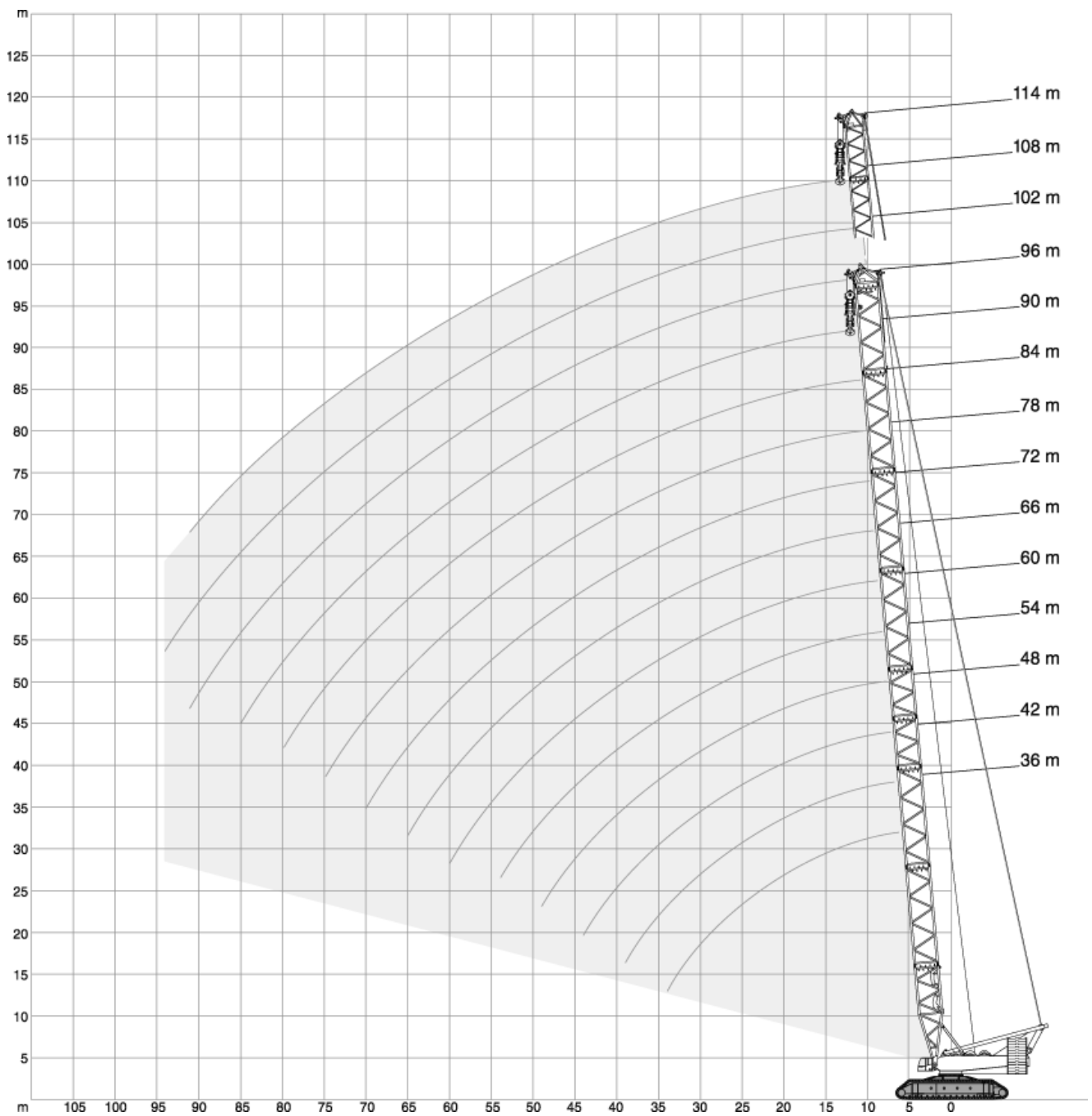

		170-250 t		0-80 t ZB		9,60 m		9.8 m/s		360°		ISO											
		36,0 m		42,0 m		48,0 m		54,0 m		60,0 m		66,0 m		72,0 m		78,0 m		84,0 m		90,0 m		96,0 m	
		t		t		t		t		t		t		t		t		t		t		t	
7	791,0	-	-	-	-	-	-	-	-	-	-	-	-	-	-	-	-	-	-	-	-	-	-
8	696,0	691,0	681,0	-	-	-	-	-	-	-	-	-	-	-	-	-	-	-	-	-	-	-	-
9	620,0	616,0	592,0	556,0	-	-	-	-	-	-	-	-	-	-	-	-	-	-	-	-	-	-	-
10	559,0	554,0	523,0	493,0	466,0	441,0	-	-	-	-	-	-	-	-	-	-	-	-	-	-	-	-	-
11	507,0	494,0	467,0	442,0	419,0	398,0	378,0	360,0	-	-	-	-	-	-	-	-	-	-	-	-	-	-	-
12	459,0	444,0	421,0	400,0	380,0	362,0	345,0	329,0	313,0	299,0	-	-	-	-	-	-	-	-	-	-	-	-	-
13	418,0	403,0	383,0	365,0	348,0	332,0	316,0	302,0	288,0	276,0	250,0	-	-	-	-	-	-	-	-	-	-	-	-
14	383,0	368,0	351,0	335,0	319,0	306,0	292,0	279,0	266,0	255,0	243,0	-	-	-	-	-	-	-	-	-	-	-	-
16	322,0	313,0	299,0	286,0	274,0	262,0	251,0	241,0	230,0	220,0	210,0	-	-	-	-	-	-	-	-	-	-	-	-
18	267,0	265,0	259,0	249,0	238,0	229,0	219,0	210,0	201,0	192,0	184,0	-	-	-	-	-	-	-	-	-	-	-	-
20	227,0	225,0	223,0	219,0	209,0	201,0	193,0	185,0	177,0	169,0	162,0	-	-	-	-	-	-	-	-	-	-	-	-
22	197,0	194,0	192,0	190,0	186,0	179,0	171,0	164,0	157,0	150,0	143,0	-	-	-	-	-	-	-	-	-	-	-	-
24	172,0	170,0	167,0	165,0	163,0	160,0	153,0	147,0	140,0	134,0	127,0	-	-	-	-	-	-	-	-	-	-	-	-
26	153,0	150,0	148,0	146,0	144,0	142,0	138,0	132,0	126,0	120,0	114,0	-	-	-	-	-	-	-	-	-	-	-	-
28	137,0	134,0	132,0	129,0	127,0	126,0	124,0	119,0	113,0	108,0	102,0	-	-	-	-	-	-	-	-	-	-	-	-
30	124,0	121,0	118,0	116,0	114,0	112,0	111,0	108,0	102,0	97,5	92,0	-	-	-	-	-	-	-	-	-	-	-	-
34	103,0	100,0	97,0	94,5	92,5	91,0	89,0	87,0	84,0	79,5	74,5	-	-	-	-	-	-	-	-	-	-	-	-
38	-	84,0	81,0	78,5	76,0	74,5	72,0	70,0	67,5	65,5	60,5	-	-	-	-	-	-	-	-	-	-	-	-
39	-	81,0	77,7	75,2	72,5	70,7	68,5	66,2	63,7	61,7	57,5	-	-	-	-	-	-	-	-	-	-	-	-
42	-	-	69,0	66,2	63,0	61,0	58,7	56,5	53,6	51,5	48,5	-	-	-	-	-	-	-	-	-	-	-	-
44	-	-	63,5	60,5	57,0	55,0	52,5	50,5	47,9	45,9	42,6	-	-	-	-	-	-	-	-	-	-	-	-
46	-	-	-	55,7	52,4	50,3	47,7	45,5	42,9	40,8	37,3	-	-	-	-	-	-	-	-	-	-	-	-
49	-	-	-	49,4	45,9	43,5	41,0	38,6	35,7	33,7	30,4	-	-	-	-	-	-	-	-	-	-	-	-
50	-	-	-	-	43,9	41,6	39,0	36,6	33,6	31,7	28,3	-	-	-	-	-	-	-	-	-	-	-	-
54	-	-	-	-	37,0	34,5	31,5	29,2	26,3	24,1	20,6	-	-	-	-	-	-	-	-	-	-	-	-
58	-	-	-	-	-	28,6	25,5	22,9	19,8	17,7	14,3	-	-	-	-	-	-	-	-	-	-	-	-
60	-	-	-	-	-	25,9	22,7	20,1	17,0	14,8	11,4	-	-	-	-	-	-	-	-	-	-	-	-
62	-	-	-	-	-	-	20,3	17,6	14,5	12,2	8,8	-	-	-	-	-	-	-	-	-	-	-	-
63	-	-	-	-	-	-	19,1	16,4	13,3	10,9	7,5	-	-	-	-	-	-	-	-	-	-	-	-
65	-	-	-	-	-	-	17,0	14,1	11,0	8,6	-	-	-	-	-	-	-	-	-	-	-	-	-
66	-	-	-	-	-	-	-	13,1	10,0	7,5	-	-	-	-	-	-	-	-	-	-	-	-	-
68	-	-	-	-	-	-	-	-	11,1	7,9	-	-	-	-	-	-	-	-	-	-	-	-	-
70	-	-	-	-	-	-	-	-	9,3	-	-	-	-	-	-	-	-	-	-	-	-	-	-

		170-250 t		0-80 t ZB		9,60 m		9.8 m/s		360°		ISO											
		48,0 m		54,0 m		60,0 m		66,0 m		72,0 m		78,0 m		84,0 m		90,0 m		96,0 m		102,0 m		108,0 m	
		t		t		t		t		t		t		t		t		t		t		t	
8	8	506,0	-	-	-	-	-	-	-	-	-	-	-	-	-	-	-	-	-	-	-	-	-
9	9	506,0	506,0	506,0	-	-	-	-	-	-	-	-	-	-	-	-	-	-	-	-	-	-	-
10	10	506,0	501,0	474,0	451,0	429,0	-	-	-	-	-	-	-	-	-	-	-	-	-	-	-	-	-
11	11	468,0	455,0	431,5	412,0	393,0	373,0	357,0	-	-	-	-	-	-	-	-	-	-	-	-	-	-	-
12	12	430,0	409,0	389,0	373,0	357,0	342,0	328,0	315,0	300,0	-	-	-	-	-	-	-	-	-	-	-	-	-
13	13	395,0	376,5	359,0	344,5	330,5	317,5	305,0	293,0	279,5	268,0	242,0	-	-	-	-	-	-	-	-	-	-	-
14	14	360,0	344,0	329,0	316,0	304,0	293,0	282,0	271,0	259,0	250,0	241,0	-	-	-	-	-	-	-	-	-	-	-
16	16	309,0	296,0	283,0	274,0	263,0	254,0	245,0	237,0	226,0	219,0	212,0	-	-	-	-	-	-	-	-	-	-	-
18	18	269,0	258,0	248,0	240,0	232,0	224,0	217,0	210,0	200,0	194,0	188,0	-	-	-	-	-	-	-	-	-	-	-
20	20	231,0	229,0	220,0	213,0	206,0	199,0	193,0	187,0	178,0	173,0	168,0	-	-	-	-	-	-	-	-	-	-	-
22	22	203,5	201,5	196,0	192,5	186,5	180,5	175,0	169,5	161,5	156,5	152,0	-	-	-	-	-	-	-	-	-	-	-
24	24	176,0	174,0	172,0	172,0	167,0	162,0	157,0	152,0	145,0	140,0	136,0	-	-	-	-	-	-	-	-	-	-	-
26	26	158,5	156,0	154,0	154,0	151,5	148,0	143,5	139,0	132,5	128,0	124,5	-	-	-	-	-	-	-	-	-	-	-
28	28	141,0	138,0	136,0	136,0	136,0	134,0	130,0	126,0	120,0	116,0	113,0	-	-	-	-	-	-	-	-	-	-	-
30	30	128,5	125,5	123,5	123,5	123,0	122,0	119,5	116,0	110,0	106,7	104,0	-	-	-	-	-	-	-	-	-	-	-
34	34	106,7	103,7	101,7	101,5	100,7	100,5	99,5	97,7	92,5	90,0	87,5	-	-	-	-	-	-	-	-	-	-	-
38	38	90,5	87,5	85,2	85,0	84,2	83,7	82,7	82,2	78,2	76,2	74,0	-	-	-	-	-	-	-	-	-	-	-
42	42	78,2	75,3	72,6	72,5	71,5	71,0	70,0	69,3	65,6	64,1	62,5	-	-	-	-	-	-	-	-	-	-	-
44	44	73,0	70,1	67,3	67,0	66,0	65,5	64,5	63,6	59,8	58,3	57,0	-	-	-	-	-	-	-	-	-	-	-
46	46	-	65,0	62,0	61,5	60,5	60,0	59,0	58,0	54,0	52,5	51,5	-	-	-	-	-	-	-	-	-	-	-
49	49	-	59,0	56,2	55,5	54,4	53,6	52,5	51,6	47,5	46,0	44,9	-	-	-	-	-	-	-	-	-	-	-
50	50	-	-	54,3	53,5	52,3	51,5	50,3	49,5	45,3	43,9	42,7	-	-	-	-	-	-	-	-	-	-	-
54	54	-	-	47,3	46,5	45,1	44,0	42,7	41,9	37,5	36,2	35,3	-	-	-	-	-	-	-	-	-	-	-
58	58	-	-	-	40,3	38,7	37,5	36,2	35,3	31,0	29,6	28,6	-	-	-	-	-	-	-	-	-	-	-
59	59	-	-	-	39,0	37,4	36,1	34,7	34,0	29,6	28,1	27,2	-	-	-	-	-	-	-	-	-	-	-
62	62	-	-	-	-	33,6	32,3	30,9	30,1	25,5	24,2	23,2	-	-	-	-	-	-	-	-	-	-	-
65	65	-	-	-	-	30,3	28,9	27,3	26,4	22,0	20,5	19,5	-	-	-	-	-	-	-	-	-	-	-
66	66	-	-	-	-	-	27,9	26,3	25,3	21,0	19,5	18,4	-	-	-	-	-	-	-	-	-	-	-
70	70	-	-	-	-	-	24,1	22,3	21,2	16,8	15,3	14,2	-	-	-	-	-	-	-	-	-	-	-
74	74	-	-	-	-	-	-	19,0	17,8	13,3	11,8	10,7	-	-	-	-	-	-	-	-	-	-	-
75	75	-	-	-	-	-	-	18,2	17,0	12,5	10,9	9,8	-	-	-	-	-	-	-	-	-	-	-
78	78	-	-	-	-	-	-	-	14,8	10,3	8,6	7,5	-	-	-	-	-	-	-	-	-	-	-
80	80	-	-	-	-	-	-	-	13,4	8,9	7,2	6,1	-	-	-	-	-	-	-	-	-	-	-
81	81	-	-	-	-	-	-	-	-	8,2	6,5	5,4	-	-	-	-	-	-	-	-	-	-	-
82	82	-	-	-	-	-	-	-	-	7,5	5,8	-	-	-	-	-	-	-	-	-	-	-	-
83	83	-	-	-	-	-	-	-	-	6,9	5,2	-	-	-	-	-	-	-	-	-	-	-	-
85	85	-	-	-	-	-	-	-	-	5,7	-	-	-	-	-	-	-	-	-	-	-	-	-

		170-250 t		0-80 t ZB		9,60 m		9.8 m/s		360°		ISO																	
		42,0m		48,0m		54,0m		60,0m		66,0m		72,0m		78,0m		84,0m		90,0m		96,0m		102,0m		108,0m		114,0m			
		t		t		t		t		t		t		t		t		t		t		t		t		t			
m		t		t		t		t		t		t		t		t		t		t		t		t		t		m	
8	506,0	506,0	-	-	-	-	-	-	-	-	-	-	-	-	-	-	-	-	-	-	-	-	-	-	-	-	8		
9	506,0	506,0	506,0	493,0	-	-	-	-	-	-	-	-	-	-	-	-	-	-	-	-	-	-	-	-	-	-	9		
10	506,0	506,0	505,0	480,0	431,0	361,0	-	-	-	-	-	-	-	-	-	-	-	-	-	-	-	-	-	-	-	-	10		
11	480,0	469,5	459,0	438,0	405,0	355,0	313,0	260,0	-	-	-	-	-	-	-	-	-	-	-	-	-	-	-	-	-	-	11		
12	454,0	433,0	413,0	396,0	379,0	349,0	313,0	260,0	230,0	194,0	-	-	-	-	-	-	-	-	-	-	-	-	-	-	-	-	12		
13	416,0	398,0	381,0	365,5	350,5	329,5	305,5	257,5	228,0	194,0	172,0	143,0	-	-	-	-	-	-	-	-	-	-	-	-	-	-	13		
14	378,0	363,0	349,0	335,0	322,0	310,0	298,0	255,0	226,0	194,0	172,0	143,0	123,0	-	-	-	-	-	-	-	-	-	-	-	-	-	14		
16	323,0	312,0	301,0	290,0	280,0	270,0	260,0	246,0	219,0	188,0	170,0	141,0	123,0	-	-	-	-	-	-	-	-	-	-	-	-	-	16		
18	275,0	273,0	263,0	255,0	246,0	239,0	230,0	223,0	211,0	183,0	166,0	138,0	120,0	-	-	-	-	-	-	-	-	-	-	-	-	-	18		
20	235,0	234,0	233,0	227,0	220,0	213,0	205,0	200,0	193,0	177,0	162,0	134,0	117,0	-	-	-	-	-	-	-	-	-	-	-	-	-	20		
22	207,5	206,5	205,5	202,5	199,0	193,5	186,5	182,0	176,0	166,0	156,0	130,5	113,5	-	-	-	-	-	-	-	-	-	-	-	-	-	22		
24	180,0	179,0	178,0	178,0	178,0	174,0	168,0	164,0	159,0	155,0	150,0	127,0	110,0	-	-	-	-	-	-	-	-	-	-	-	-	-	24		
26	162,0	161,5	160,0	160,0	160,0	157,5	154,0	150,5	146,0	142,5	138,0	124,5	107,5	-	-	-	-	-	-	-	-	-	-	-	-	-	26		
28	144,0	144,0	142,0	142,0	142,0	141,0	140,0	137,0	133,0	130,0	126,0	122,0	105,0	-	-	-	-	-	-	-	-	-	-	-	-	-	28		
30	131,5	131,5	129,5	129,5	129,0	128,5	127,5	125,5	123,0	120,5	116,5	113,0	102,5	-	-	-	-	-	-	-	-	-	-	-	-	-	30		
34	110,0	109,5	108,0	107,7	107,0	106,7	105,5	105,0	104,0	102,5	99,7	97,0	93,5	-	-	-	-	-	-	-	-	-	-	-	-	-	34		
38	94,3	93,2	92,0	91,5	90,7	90,2	88,7	88,7	87,7	86,7	85,2	83,7	81,2	-	-	-	-	-	-	-	-	-	-	-	-	-	38		
39	91,0	89,8	88,5	88,0	87,1	86,6	85,1	85,1	84,1	83,1	81,6	80,6	78,3	-	-	-	-	-	-	-	-	-	-	-	-	-	39		
42	-	81,2	79,8	79,1	78,1	77,6	76,0	76,0	75,0	74,0	72,5	72,0	70,0	-	-	-	-	-	-	-	-	-	-	-	-	-	42		
44	-	76,0	74,6	73,8	72,8	72,3	70,5	70,5	69,5	68,5	67,0	66,5	64,5	-	-	-	-	-	-	-	-	-	-	-	-	-	44		
46	-	-	69,5	68,5	67,5	67,0	65,0	65,0	64,0	63,0	61,5	61,0	59,0	-	-	-	-	-	-	-	-	-	-	-	-	-	46		
49	-	-	63,5	62,7	61,5	61,0	59,0	59,0	57,7	56,7	55,2	54,5	52,6	-	-	-	-	-	-	-	-	-	-	-	-	-	49		
50	-	-	-	60,8	59,5	59,0	57,0	57,0	55,6	54,6	53,1	52,3	50,4	-	-	-	-	-	-	-	-	-	-	-	-	-	50		
54	-	-	-	54,0	52,7	52,0	49,9	49,7	48,3	47,3	45,6	44,6	42,8	-	-	-	-	-	-	-	-	-	-	-	-	-	54		
58	-	-	-	-	47,1	46,0	43,8	43,3	42,0	40,9	39,0	38,0	36,1	-	-	-	-	-	-	-	-	-	-	-	-	-	58		
59	-	-	-	-	45,8	44,7	42,5	42,0	40,7	39,6	37,6	36,6	34,7	-	-	-	-	-	-	-	-	-	-	-	-	-	59		
62	-	-	-	-	-	41,1	38,7	38,1	36,8	35,7	33,6	32,5	30,8	-	-	-	-	-	-	-	-	-	-	-	-	-	62		
65	-	-	-	-	-	37,7	35,2	34,5	33,1	31,9	30,1	29,0	27,0	-	-	-	-	-	-	-	-	-	-	-	-	-	65		
66	-	-	-	-	-	-	34,2	33,5	32,0	30,8	29,0	27,9	25,9	-	-	-	-	-	-	-	-	-	-	-	-	-	66		
70	-	-	-	-	-	-	-	30,4	29,5	28,0	26,8	24,8	21,8	-	-	-	-	-	-	-	-	-	-	-	-	-	70		
74	-	-	-	-	-	-	-	-	26,2	24,6	23,3	21,3	20,3	18,3	-	-	-	-	-	-	-	-	-	-	-	-	74		
75	-	-	-	-	-	-	-	-	25,4	23,8	22,5	20,5	19,4	17,4	-	-	-	-	-	-	-	-	-	-	-	-	75		
78	-	-	-	-	-	-	-	-	-	21,5	20,3	18,3	17,1	15,1	-	-	-	-	-	-	-	-	-	-	-	-	78		
80	-	-	-	-	-	-	-	-	-	20,2	18,9	16,9	15,7	13,6	-	-	-	-	-	-	-	-	-	-	-	-	80		
82	-	-	-	-	-	-	-	-	-	-	17,6	15,5	14,3	12,3	-	-	-	-	-	-	-	-	-	-	-	-	82		
85	-	-	-	-	-	-	-	-	-	-	15,8	13,7	12,4	10,5	-	-	-	-	-	-	-	-	-	-	-	-	85		
86	-	-	-	-	-	-	-	-	-	-	-	13,1	11,9	9,9	-	-	-	-	-	-	-	-	-	-	-	-	86		
90	-	-	-	-	-	-	-	-	-	-	-	11,0	9,8	7,7	-	-	-	-	-	-	-	-	-	-	-	-	90		
91	-	-	-	-	-	-	-	-	-	-	-	10,6	9,3	7,2	-	-	-	-	-	-	-	-	-	-	-	-	91		
94	-	-	-	-	-	-	-	-	-	-	-	-	7,9	5,7	-	-	-	-	-	-	-	-	-	-	-	-	94		
95	-	-	-	-	-	-	-	-	-	-	-	-	7,4	5,3	-	-	-	-	-	-	-	-	-	-	-	-	95		
96	-	-	-	-	-	-	-	-	-	-	-	-	7,0	-	-	-	-	-	-	-	-	-	-	-	-	-	96		
98	-	-	-	-	-	-	-	-	-	-	-	-	-	-	-	-	-	-	-	-	-	-	-	-	-	-	98		

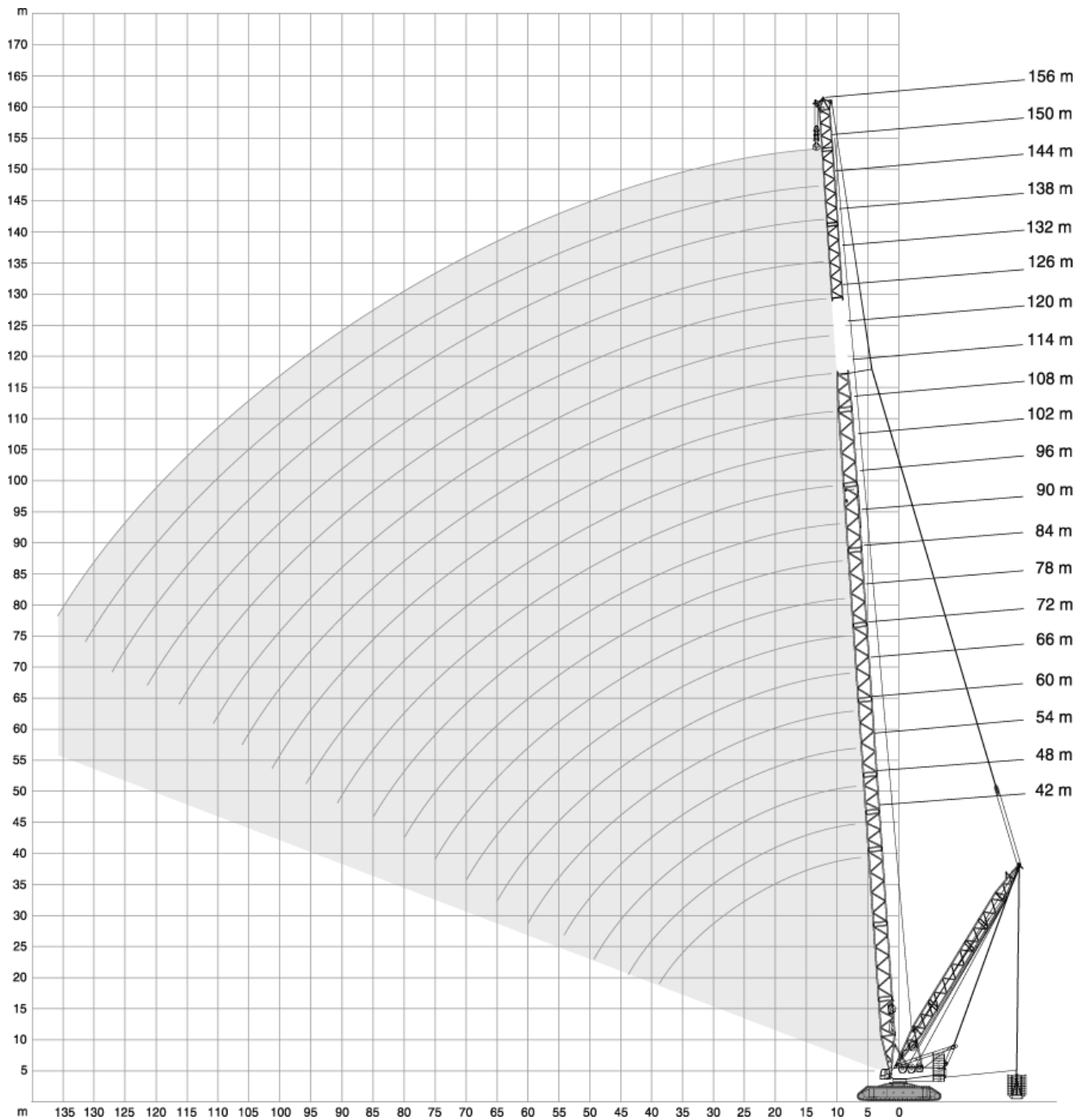

		170-250 t 0-80 t ZB		15-24 m		9,60 m		9.8 m/s		360°		ISO	
		42 m		48 m		54 m		60 m		66 m			
		0 t	80-450t	0 t	80-450t	0 t	80-450t	0 t	80-450t	0 t	80-450t		
m	t	t	t	t	t	t	t	t	t	t	t	m	
8	761,0	1250,0	757,0	1186,0	-	-	-	-	-	-	-	8	
9	678,0	1246,0	674,0	1186,0	645,0	1037,0	-	-	-	-	-	9	
10	602,0	1243,0	602,0	1186,0	573,0	1037,0	542,0	959,0	514,0	841,0		10	
12	470,0	1127,0	468,0	1123,0	467,0	1037,0	445,0	959,0	424,0	841,0		12	
14	382,0	988,0	379,0	984,0	378,0	981,0	375,0	959,0	359,0	841,0		14	
16	329,0	865,0	316,0	861,0	314,0	858,0	313,0	855,0	310,0	841,0		16	
18	281,0	768,0	278,0	764,0	267,0	761,0	266,0	758,0	265,0	756,0		18	
20	244,0	690,0	241,0	686,0	239,0	683,0	229,0	680,0	228,0	678,0		20	
22	214,0	625,0	211,0	622,0	209,0	619,0	207,0	616,0	206,0	613,0		22	
24	190,0	568,0	187,0	568,0	184,0	565,0	182,0	562,0	181,0	560,0		24	
26	170,0	505,0	167,0	522,0	164,0	519,0	162,0	516,0	160,0	514,0		26	
28	153,0	451,0	150,0	483,0	147,0	480,0	144,0	477,0	143,0	474,0		28	
30	139,0	416,0	135,0	447,0	132,0	446,0	130,0	442,0	128,0	440,0		30	
34	115,0	340,0	112,0	368,0	109,0	389,0	106,0	386,0	104,0	384,0		34	
38	98,0	285,0	94,0	315,0	91,0	334,0	88,0	341,0	86,0	339,0		38	
39	94,0	269,0	90,2	301,0	87,2	320,0	84,0	331,5	82,0	329,5		39	
42	-	-	80,2	261,0	77,0	281,5	73,5	301,0	71,5	303,5		42	
44	-	-	74,0	237,0	70,5	262,0	67,0	280,0	65,0	287,0		44	
46	-	-	-	-	65,2	243,5	61,7	259,5	59,5	272,0		46	
49	-	-	-	-	58,0	214,0	54,3	229,7	51,8	248,2		49	
50	-	-	-	-	-	-	52,2	223,0	49,7	239,5		50	
54	-	-	-	-	-	-	44,1	195,0	41,6	206,0		54	
58	-	-	-	-	-	-	-	-	34,7	180,5		58	
60	-	-	-	-	-	-	-	-	31,6	170,0		60	
64	-	-	-	-	-	-	-	-	-	-		64	

		72 m		78 m		84 m		90 m		96 m			
		0 t	80-450t	0 t	80-450t	0 t	80-450t	0 t	80-450t	0 t	80-450t		
m	t	t	t	t	t	t	t	t	t	t	t	m	
11	443,0	760,0	422,0	677,0	-	-	-	-	-	-	-	11	
12	404,0	760,0	387,0	677,0	369,0	625,0	353,0	559,0	-	-	-	12	
13	372,0	760,0	356,0	677,0	340,0	625,0	326,0	559,0	312,0	498,0		13	
14	343,0	760,0	329,0	677,0	315,0	625,0	302,0	559,0	289,0	498,0		14	
16	297,0	760,0	285,0	677,0	273,0	625,0	263,0	559,0	252,0	498,0		16	
18	260,0	749,0	250,0	677,0	240,0	616,0	231,0	559,0	221,0	498,0		18	
20	227,0	675,0	222,0	666,0	213,0	604,0	205,0	550,0	196,0	498,0		20	
22	197,0	611,0	196,0	608,0	190,0	595,0	183,0	539,0	175,0	490,0		22	
24	180,0	557,0	172,0	554,0	170,0	551,0	164,0	535,0	157,0	482,0		24	
26	159,0	511,0	157,0	509,0	149,0	505,0	148,0	503,0	142,0	478,0		26	
28	141,0	472,0	140,0	469,0	137,0	466,0	130,0	464,0	127,0	460,0		28	
30	126,0	437,0	124,0	435,0	122,0	432,0	120,0	429,0	116,0	426,0		30	
34	102,0	381,0	100,0	378,0	97,5	375,0	96,0	373,0	92,5	369,0		34	
38	83,5	336,0	81,5	333,0	78,5	330,0	77,0	328,0	73,0	324,0		38	
42	69,2	300,5	66,7	297,5	63,7	294,5	61,7	292,5	58,2	288,5		42	
46	57,0	270,0	54,6	267,5	51,6	264,0	49,5	262,0	45,9	258,0		46	
50	47,0	244,0	44,6	242,0	41,5	238,5	39,3	236,5	35,6	232,5		50	
54	38,6	218,5	36,1	219,5	32,9	217,0	30,6	215,0	26,9	211,0		54	
58	31,5	191,5	28,8	199,0	25,6	198,0	23,2	196,0	19,5	192,0		58	
62	25,4	166,0	22,6	177,0	19,3	181,0	16,8	179,5	13,1	175,5		62	
65	21,4	155,0	18,5	160,0	15,1	168,0	12,6	168,5	8,8	164,5		65	
66	-	-	17,3	154,3	13,9	163,0	11,3	165,0	7,5	161,0		66	
69	-	-	13,8	142,0	10,3	148,0	7,6	154,0	-	152,0		69	
70	-	-	12,7	139,0	9,2	143,0	-	149,6	-	149,0		70	
72	-	-	-	-	7,0	133,0	-	141,0	-	143,0		72	
74	-	-	-	-	-	126,3	-	132,5	-	135,5		74	
75	-	-	-	-	-	124,0	-	128,2	-	131,7		75	
78	-	-	-	-	-	-	-	115,5	-	120,5		78	
80	-	-	-	-	-	-	-	111,0	-	113,0		80	
82	-	-	-	-	-	-	-	-	-	106,0		82	
85	-	-	-	-	-	-	-	-	-	98,0		85	

Lifting capacities > 1000 t only with special equipment · Werte > 1000 t nur mit Sonderausrüstung · Capacités de levage > 1000 t uniquement avec équipement special · Capacità di sollevamento > 1000 t solo con attrezzatura speciale · Capacidades de elevación > 1000 t sólo con equipamiento especial · Capacidades de içamento > 1000 t somente com equipamento especial · Грузоподъемность > 1000 т только со специальным оборудованием

SSL/LSL, SSL/LSL S1

CC 6800





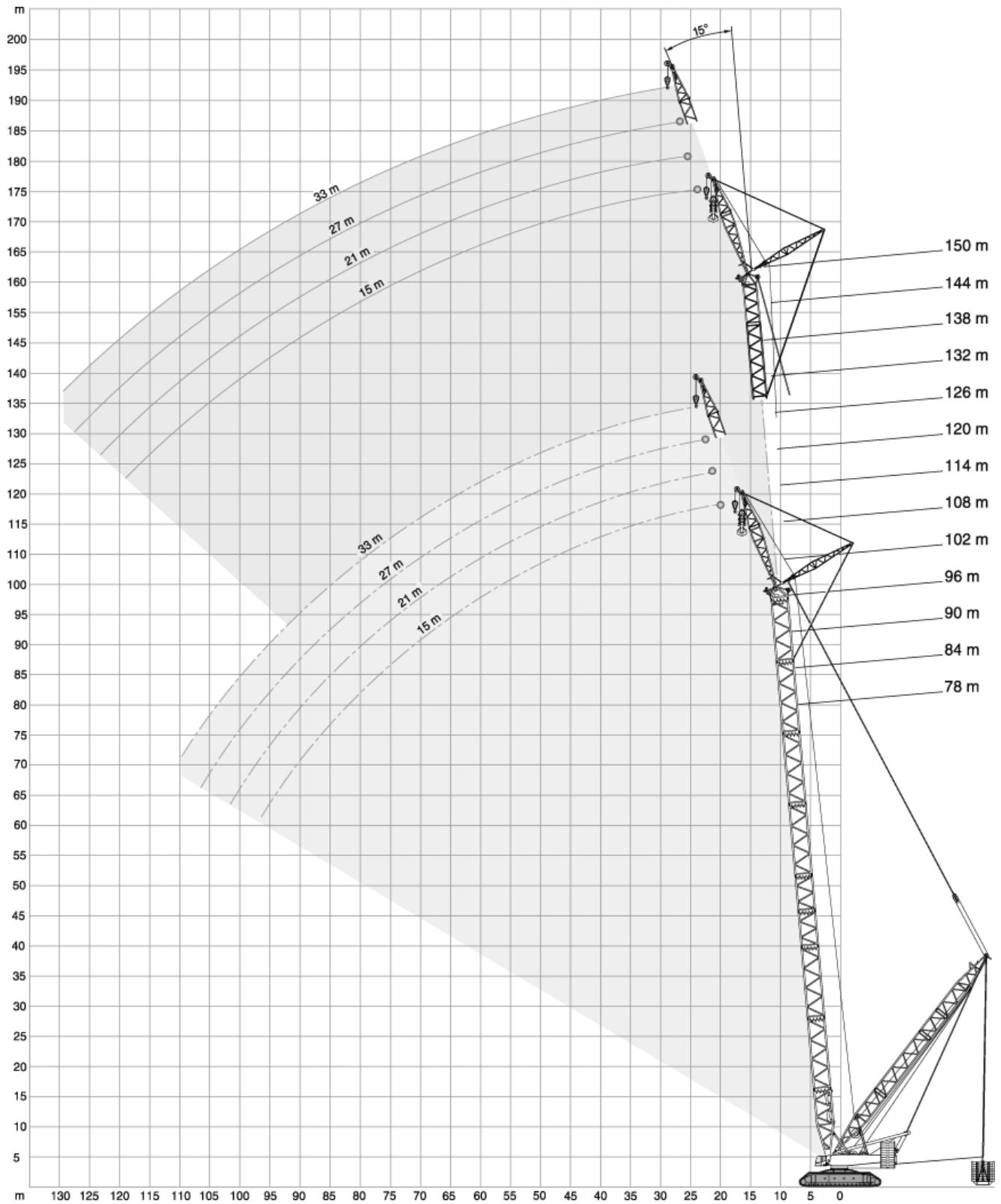















170-250 t		0-80 t ZB		15-24 m			9,60 m			9.8 m/s			360°		ISO			
102 m		108 m			114 m			120 m			126 m							
SSL/LSL		SSL/LSL S1			SSL/LSL			SSL/LSL S1			SSL/LSL			SSL/LSL S1				
0 t		80-450t			0 t			80-450t			0 t			80-450t				
m	t	t	t	t	t	t	t	t	t	t	t	t	t	t	t	t	m	
13	308,0	450,0	438,0	294,0	405,0	396,0	-	-	-	-	-	-	-	-	-	-	13	
14	288,0	450,0	438,0	275,0	405,0	396,0	265,0	364,0	358,0	256,0	330,0	325,0	-	-	-	-	14	
15	268,0	450,0	438,0	256,0	405,0	396,0	248,0	364,0	358,0	239,0	330,0	325,0	231,0	296,0	288,0	15	15	
16	252,0	450,0	438,0	241,0	405,0	396,0	233,5	364,0	358,0	225,0	330,0	325,0	218,0	296,0	288,0	16	16	
18	223,0	450,0	438,0	213,0	405,0	396,0	207,0	364,0	358,0	199,5	330,0	325,0	193,5	296,0	288,0	18	18	
20	199,0	450,0	438,0	189,5	405,0	395,5	184,5	364,0	358,0	178,0	330,0	325,0	173,0	296,0	288,0	20	20	
22	179,0	442,3	433,0	170,3	405,0	394,3	165,6	364,0	357,0	160,0	330,0	323,6	156,0	296,0	288,0	22	22	
24	161,0	441,0	433,0	153,0	405,0	393,0	149,0	364,0	355,0	144,0	330,0	321,0	140,0	296,0	288,0	24	24	
26	147,0	433,0	429,0	139,5	394,0	389,5	136,0	359,0	353,5	131,5	329,0	317,5	127,5	296,0	288,0	26	26	
28	133,0	432,0	429,0	126,0	394,0	388,0	123,0	359,0	353,0	119,0	328,0	316,0	115,0	296,0	288,0	28	28	
30	122,0	417,5	414,0	114,0	389,0	378,5	112,0	355,0	350,0	109,0	325,0	315,5	105,5	293,5	288,0	30	30	
34	100,2	378,0	379,5	93,5	368,5	362,5	92,5	347,5	337,0	88,5	317,5	309,5	86,2	288,0	286,5	34	34	
38	81,2	332,5	335,0	76,5	328,0	331,5	75,5	326,0	319,5	71,5	311,0	294,5	70,2	282,0	277,0	38	38	
42	66,5	296,3	299,0	61,6	292,3	295,3	60,5	291,0	293,3	58,6	289,0	277,3	57,5	268,6	267,3	42	42	
46	53,5	265,0	267,0	48,8	261,0	264,0	47,7	259,0	262,0	45,8	257,0	258,0	44,5	256,0	258,0	46	46	
50	43,7	240,3	243,0	39,0	236,3	239,3	37,9	235,0	237,3	35,9	233,0	233,3	34,6	231,3	234,0	50	50	
54	34,9	218,3	221,3	30,2	214,3	217,3	29,1	213,3	215,3	27,1	211,3	211,3	25,8	209,3	212,3	54	54	
58	27,3	199,0	202,0	22,6	195,0	198,0	21,5	194,0	196,0	19,5	192,0	192,0	18,2	190,0	193,0	58	58	
62	21,2	183,0	185,3	16,4	179,0	182,6	15,3	178,0	180,0	13,3	176,0	176,6	12,0	174,0	177,0	62	62	
66	15,7	168,3	170,3	10,9	164,3	168,0	9,7	163,2	165,6	7,7	161,0	162,2	6,2	160,0	162,6	66	66	
68	13,2	161,6	163,6	8,4	157,6	161,0	7,1	156,4	159,3	5,1	154,0	155,4	-	153,5	156,2	68	68	
69	12,0	158,3	160,3	7,2	154,3	157,5	5,9	153,0	156,1	-	151,0	152,0	-	150,2	153,0	69	69	
70	10,8	155,0	157,0	6,0	151,0	154,0	-	150,0	153,0	-	148,0	149,0	-	147,0	149,0	70	70	
74	6,6	143,8	146,3	-	140,3	143,0	-	139,3	141,5	-	137,3	138,3	-	135,6	138,3	74	74	
75	5,6	141,0	143,6	-	137,6	140,5	-	136,6	138,7	-	134,6	135,6	-	132,8	135,6	75	75	
78	-	132,3	135,6	-	130,0	133,3	-	129,3	131,3	-	127,3	128,0	-	125,3	128,3	78	78	
82	-	121,0	124,0	-	120,0	124,0	-	120,0	122,0	-	118,0	118,0	-	116,0	119,0	82	82	
86	-	108,3	111,3	-	108,6	112,6	-	111,3	114,0	-	109,3	110,0	-	108,0	110,3	86	86	
90	-	95,6	98,6	-	97,5	101,5	-	101,6	104,6	-	101,0	102,0	-	100,6	102,6	90	90	
91	-	94,0	96,5	-	94,7	98,7	-	99,0	102,0	-	99,0	100,0	-	98,9	101,0	91	91	
94	-	-	-	-	86,5	90,5	-	91,0	94,0	-	93,0	94,0	-	93,5	96,0	94	94	
96	-	-	-	-	83,0	86,0	-	86,0	88,8	-	88,2	89,5	-	89,5	93,0	96	96	
98	-	-	-	-	-	-	-	81,0	83,6	-	83,6	84,7	-	85,5	88,7	98	98	
101	-	-	-	-	-	-	-	75,0	77,5	-	76,7	77,7	-	79,4	82,4	101	101	
102	-	-	-	-	-	-	-	-	-	-	74,5	75,5	-	77,3	80,3	102	102	
106	-	-	-	-	-	-	-	-	-	-	67,5	68,0	-	69,0	72,0	106	106	
110	-	-	-	-	-	-	-	-	-	-	-	-	-	61,6	63,6	110	110	
111	-	-	-	-	-	-	-	-	-	-	-	-	-	60,5	62,5	111	111	

170-250 t		0-80 t ZB		15-24 m			9,60 m			9.8 m/s			360°		ISO	
m	132 m			138 m			144 m			150 m			156 m			m
	SSL/LSL	SSL/LSL S1		SSL/LSL	SSL/LSL S1		SSL/LSL	SSL/LSL S1		SSL/LSL	SSL/LSL S1		SSL/LSL	SSL/LSL S1		
	0 t	80-450t		0 t	80-450t		0 t	80-450t		0 t	80-450t		0 t	80-450t		
	t	t	t	t	t	t	t	t	t	t	t	t	t	t	t	
15	225,0	266,0	262,0	-	-	-	-	-	-	-	-	-	-	-	-	15
16	212,0	266,0	262,0	205,0	239,0	240,0	-	-	-	-	-	-	-	-	-	16
17	199,0	266,0	262,0	193,0	239,0	239,0	187,0	209,0	219,0	171,0	184,0	199,0	-	-	-	17
18	188,5	266,0	262,0	182,5	239,0	239,0	177,0	208,5	219,0	163,0	183,5	199,0	-	-	180,0	18
20	168,5	266,0	262,0	163,0	238,5	239,0	158,5	207,5	219,0	154,0	182,0	199,0	-	-	180,0	20
22	151,3	266,0	262,0	146,6	238,0	238,6	143,0	206,0	219,0	139,0	180,0	199,0	-	-	180,0	22
24	136,0	266,0	262,0	132,0	238,0	238,0	129,0	204,0	219,0	125,0	178,0	199,0	-	-	180,0	24
26	124,0	266,0	262,0	120,5	237,5	238,0	117,5	202,5	219,0	114,0	176,0	199,0	-	-	180,0	26
28	112,0	266,0	262,0	109,0	237,0	238,0	106,0	201,0	219,0	103,0	174,0	199,0	-	-	180,0	28
30	102,7	265,5	262,0	99,7	235,5	238,0	97,2	199,0	218,5	94,2	172,0	198,5	-	-	179,0	30
34	84,7	262,5	262,0	82,5	232,0	238,0	81,0	194,5	217,5	78,2	167,0	197,0	-	-	178,0	34
38	69,5	254,5	255,5	66,2	224,0	236,0	65,2	189,0	216,5	63,2	161,0	196,5	-	-	177,5	38
42	56,6	245,6	248,6	52,7	215,0	229,3	51,8	183,3	211,3	50,3	155,0	193,3	-	-	176,0	42
46	43,8	235,0	244,0	42,3	206,0	224,0	41,6	178,0	206,0	40,0	149,0	189,0	-	-	172,0	46
50	33,9	223,6	226,6	32,4	198,6	218,0	31,6	166,6	202,6	30,0	144,2	185,6	-	-	168,6	50
54	25,1	208,3	208,3	23,6	193,3	205,3	22,8	159,0	195,3	21,2	136,6	182,6	-	-	165,0	54
58	17,4	189,0	189,0	15,9	188,0	186,0	15,1	153,0	184,0	13,5	130,0	180,0	-	-	163,0	58
62	11,2	173,6	173,6	9,7	172,0	170,6	8,9	148,2	168,0	7,1	125,6	164,5	-	-	157,0	62
63	9,7	169,8	169,8	8,2	168,0	166,8	7,4	147,0	164,0	5,6	124,3	160,7	-	-	155,5	63
64	8,2	166,0	166,0	6,7	164,0	163,0	5,9	145,0	160,0	-	123,0	157,0	-	-	154,0	64
65	6,8	162,5	162,5	5,3	160,0	159,6	-	142,8	156,8	-	120,8	153,8	-	-	150,6	65
66	5,5	159,0	159,0	-	156,8	156,3	-	141,6	153,6	-	118,6	150,6	-	-	147,3	66
70	-	146,0	146,0	-	144,0	143,0	-	137,0	141,0	-	114,0	138,0	-	-	134,0	70
74	-	135,3	134,6	-	133,3	131,6	-	130,3	129,6	-	109,3	126,6	-	-	123,3	74
78	-	125,0	124,3	-	123,3	121,3	-	122,3	119,3	-	104,6	116,3	-	-	113,0	78
82	-	115,0	115,0	-	114,0	112,0	-	113,0	110,0	-	100,0	107,0	-	-	104,0	82
86	-	107,0	107,0	-	106,0	104,0	-	105,0	101,0	-	96,8	99,0	-	-	95,6	86
90	-	99,5	99,5	-	98,0	96,5	-	97,2	94,3	-	93,1	91,3	-	-	87,8	90
94	-	93,0	92,5	-	91,0	89,5	-	90,0	87,0	-	88,5	84,0	-	-	80,5	94
98	-	86,3	86,1	-	85,0	83,1	-	84,0	80,6	-	82,1	77,6	-	-	74,5	98
102	-	79,1	79,1	-	78,8	76,8	-	78,3	74,8	-	76,3	71,8	-	-	68,5	102
106	-	71,5	71,5	-	72,5	70,5	-	73,0	69,5	-	71,0	66,5	-	-	63,0	106
110	-	64,1	63,8	-	65,5	63,5	-	66,3	63,0	-	65,6	60,8	-	-	58,0	110
114	-	56,9	56,4	-	58,6	56,6	-	60,0	56,6	-	60,0	55,0	-	-	52,7	114
117	-	53,5	53,0	-	53,6	51,6	-	55,5	51,6	-	55,5	50,6	-	-	48,5	117
118	-	-	-	-	52,0	50,0	-	54,0	50,0	-	54,0	49,2	-	-	47,1	118
122	-	-	-	-	47,6	45,4	-	48,0	43,9	-	48,6	43,4	-	-	41,5	122
126	-	-	-	-	-	-	-	43,2	39,2	-	43,2	37,6	-	-	36,1	126
127	-	-	-	-	-	-	-	42,5	38,4	-	41,9	36,2	-	-	34,8	127
130	-	-	-	-	-	-	-	-	-	-	38,4	32,9	-	-	30,8	130
132	-	-	-	-	-	-	-	-	-	-	37,0	31,7	-	-	29,0	132
134	-	-	-	-	-	-	-	-	-	-	-	-	-	-	27,8	134
137	-	-	-	-	-	-	-	-	-	-	-	-	-	-	24,9	137



170-250 t 0-80 t ZB 15-24 m 15° 9,60 m 9.8 m/s 360° ISO										
78 m										
0 t 80-450t 0 t 80-450t 0 t 80-450t 0 t 80-450t										
15 m 21 m 27 m 33 m										
m	t	t	t	t	t	t	t	t	t	m
15	250,0	250,0	-	-	-	-	-	-	-	15
16	250,0	250,0	-	-	-	-	-	-	-	16
17	248,0	250,0	243,0	249,0	-	-	-	-	-	17
18	246,0	250,0	243,0	245,0	-	-	-	-	-	18
19	233,0	250,0	230,5	240,0	186,0	189,0	-	-	-	19
20	220,0	250,0	218,0	235,0	186,0	189,0	-	-	-	20
21	210,0	250,0	208,0	229,7	181,7	184,5	146,0	152,0	-	21
22	200,0	250,0	198,0	224,5	177,5	180,0	145,0	149,3	-	22
24	180,0	250,0	178,0	214,0	169,0	171,0	143,0	144,0	-	24
26	165,0	250,0	163,5	205,0	159,0	164,0	137,0	138,0	-	26
28	150,0	250,0	149,0	196,0	149,0	157,0	131,0	132,0	-	28
30	138,5	247,0	137,0	188,5	138,0	151,0	125,5	127,0	-	30
34	116,0	236,5	116,0	174,5	116,0	140,0	113,0	117,5	-	34
38	96,2	222,0	98,2	162,5	98,2	130,5	97,5	109,0	-	38
42	80,6	209,0	82,6	152,3	84,6	122,0	83,3	101,8	-	42
46	67,0	197,0	69,0	143,0	71,0	114,0	72,0	95,5	-	46
50	57,0	185,6	58,6	135,0	60,3	107,3	61,3	89,8	-	50
54	48,1	176,0	49,5	128,0	51,0	101,5	52,0	84,6	-	54
58	40,3	168,0	41,6	122,0	43,2	96,5	44,0	80,0	-	58
62	33,9	161,3	35,2	116,6	36,6	92,1	37,4	76,3	-	62
66	28,2	154,6	29,3	111,6	30,7	88,1	31,4	72,8	-	66
70	23,0	148,0	24,1	107,0	25,4	84,5	26,0	69,5	-	70
74	18,7	142,0	19,7	103,0	21,0	81,1	21,5	66,8	-	74
78	14,8	131,6	15,6	99,3	16,9	78,1	17,4	64,3	-	78
82	11,2	119,0	12,0	96,0	13,2	75,5	13,6	62,0	-	82
84	9,6	115,0	10,4	94,8	11,6	74,3	12,0	60,8	-	84
86	-	-	8,9	93,6	10,0	73,1	10,4	59,6	-	86
90	-	-	6,0	91,5	7,0	71,0	7,4	57,5	-	90
92	-	-	-	-	5,7	70,0	6,0	56,7	-	92
94	-	-	-	-	-	69,0	-	56,0	-	94
96	-	-	-	-	-	68,5	-	55,3	-	96
98	-	-	-	-	-	-	-	54,6	-	98
100	-	-	-	-	-	-	-	54,0	-	100









84 m										
m	t	t	t	t	t	t	t	t	t	m
15	250,0	250,0	-	-	-	-	-	-	-	15
16	250,0	250,0	-	-	-	-	-	-	-	16
17	243,0	250,0	240,0	248,0	-	-	-	-	-	17
18	236,0	250,0	234,0	248,0	-	-	-	-	-	18
19	224,0	250,0	222,0	242,0	183,0	190,0	-	-	-	19
20	212,0	250,0	210,0	237,0	183,0	190,0	-	-	-	20
21	202,2	250,0	200,5	232,0	180,0	186,0	147,0	153,0	-	21
22	192,5	250,0	191,0	227,0	177,0	182,0	146,0	150,6	-	22
24	173,0	250,0	172,0	217,0	171,0	174,0	144,0	146,0	-	24
26	158,5	250,0	158,0	208,5	157,5	167,0	138,0	140,0	-	26
28	144,0	250,0	144,0	200,0	144,0	160,0	132,0	134,0	-	28
30	131,5	250,0	133,0	192,5	133,0	154,0	127,0	129,0	-	30
34	110,0	242,5	110,7	179,0	112,0	143,0	113,0	119,5	-	34
38	92,5	228,0	92,7	167,5	95,2	133,5	95,0	111,0	-	38
42	77,1	214,6	79,1	157,0	81,5	125,0	80,3	104,0	-	42
46	63,5	202,0	65,5	147,0	67,5	117,0	69,0	98,0	-	46
50	53,5	191,3	55,1	139,0	57,1	110,3	58,3	92,3	-	50
54	44,6	182,0	46,0	131,6	47,9	104,5	48,9	87,1	-	54
58	36,7	174,0	38,1	125,0	39,8	99,5	40,7	82,5	-	58
62	30,3	167,3	31,6	119,6	33,2	95,1	34,1	78,5	-	62
66	24,5	160,6	25,7	114,6	27,3	91,1	28,1	75,0	-	66
70	19,3	154,0	20,5	110,0	21,9	87,5	22,7	72,0	-	70
74	15,0	147,3	16,1	106,0	17,5	83,8	18,1	69,0	-	74
78	11,0	137,0	12,0	102,3	13,4	80,6	14,0	66,3	-	78
82	7,4	123,0	8,4	99,0	9,6	78,0	10,2	64,0	-	82
84	5,8	116,0	6,8	97,7	8,0	76,5	8,5	62,8	-	84
86	-	109,0	5,2	96,5	6,4	75,0	6,9	61,6	-	86
88	-	105,0	-	95,0	-	74,0	5,3	60,5	-	88
90	-	-	-	93,8	-	73,0	-	59,5	-	90
94	-	-	-	91,5	-	71,0	-	57,5	-	94
98	-	-	-	-	-	69,3	-	55,8	-	98
100	-	-	-	-	-	68,5	-	55,0	-	100
102	-	-	-	-	-	-	-	54,5	-	102
104	-	-	-	-	-	-	-	54,0	-	104

       										
90 m										
       										
   										
m	t	t	t	t	t	t	t	t	t	m
16	250,0	250,0	-	-	-	-	-	-	-	16
18	228,0	250,0	226,0	245,0	-	-	-	-	-	18
20	204,0	250,0	203,0	239,0	181,0	188,0	-	-	-	20
22	185,5	250,0	184,5	229,5	173,5	182,0	145,0	151,0	-	22
24	167,0	250,0	166,0	220,0	166,0	176,0	145,0	147,0	-	24
26	153,0	250,0	152,5	211,5	152,5	169,0	139,5	141,5	-	26
28	139,0	250,0	139,0	203,0	139,0	162,0	134,0	136,0	-	28
30	127,5	250,0	128,0	196,0	128,5	156,5	125,5	131,0	-	30
34	107,5	245,5	107,0	182,5	108,7	145,5	109,0	121,5	-	34
38	90,0	233,5	90,2	171,0	90,7	136,0	92,2	113,5	-	38
42	74,3	219,6	76,5	161,3	76,3	128,0	77,6	106,6	-	42
46	61,0	207,0	62,5	152,0	65,0	120,0	66,0	100,0	-	46
50	50,8	196,3	52,4	143,3	54,5	114,0	55,3	94,6	-	50
54	41,7	186,6	43,3	135,6	45,2	108,0	46,0	89,6	-	54
58	33,7	178,0	35,2	129,0	37,0	102,0	38,0	85,0	-	58
62	27,3	171,3	28,7	123,6	30,4	97,6	31,3	81,0	-	62
66	21,5	165,0	22,8	118,6	24,4	93,6	25,2	77,3	-	66
70	16,3	159,0	17,5	114,0	19,0	90,0	19,8	74,0	-	70
74	11,9	147,6	13,1	109,3	14,5	86,3	15,2	71,0	-	74
78	7,9	137,5	9,0	105,5	10,4	83,0	11,0	68,3	-	78
80	6,0	133,0	7,1	104,0	8,5	81,5	9,1	67,1	-	80
82	-	127,0	5,3	102,0	6,6	80,0	7,2	66,0	-	82
84	-	120,6	-	100,5	-	78,6	5,5	64,5	-	84
86	-	114,3	-	99,0	-	77,3	-	63,5	-	86
90	-	101,8	-	96,3	-	75,0	-	61,5	-	90
94	-	93,0	-	94,0	-	73,0	-	59,5	-	94
98	-	-	-	87,8	-	71,0	-	57,5	-	98
100	-	-	-	85,0	-	70,0	-	56,5	-	100
102	-	-	-	-	-	69,2	-	55,8	-	102
104	-	-	-	-	-	68,5	-	55,1	-	104
106	-	-	-	-	-	-	-	54,5	-	106
110	-	-	-	-	-	-	-	53,5	-	110
112	-	-	-	-	-	-	-	53,0	-	112

170-250 t 0-80 t ZB 15-24 m 15° 9,60 m 9.8 m/s 360° ISO										
96 m										
m	t	t	t	t	t	t	t	t	t	m
16	247,0	250,0	-	-	-	-	-	-	-	16
18	219,0	250,0	218,0	246,0	-	-	-	-	-	18
20	196,0	250,0	195,0	241,0	182,0	189,0	-	-	-	20
22	178,0	250,0	177,5	231,5	171,0	183,0	141,0	148,0	-	22
24	160,0	250,0	160,0	222,0	160,0	177,0	141,0	148,0	-	24
26	146,5	250,0	146,5	214,5	147,0	170,5	137,0	142,5	-	26
28	133,0	250,0	133,0	207,0	134,0	164,0	133,0	137,0	-	28
30	122,5	249,5	122,5	199,5	123,5	158,5	123,0	132,0	-	30
34	101,5	248,0	102,7	186,0	104,7	148,0	104,7	123,0	-	34
38	84,2	239,5	86,7	174,5	87,7	138,5	88,5	115,5	-	38
42	70,8	225,6	73,1	164,3	73,1	130,3	74,6	108,6	-	42
46	57,5	213,0	59,5	155,0	61,5	123,0	63,0	102,0	-	46
50	47,2	201,6	49,1	147,0	51,1	116,3	52,5	96,6	-	50
54	38,1	191,6	39,8	139,3	41,8	110,3	43,1	91,6	-	54
58	30,1	183,0	31,7	132,0	33,6	105,0	34,7	87,0	-	58
62	23,7	176,3	25,1	126,6	27,0	100,3	28,0	83,0	-	62
66	17,8	167,6	19,2	121,6	21,0	96,0	21,9	79,3	-	66
70	12,6	157,0	13,9	117,0	15,6	92,0	16,5	76,0	-	70
74	8,2	145,6	9,5	113,0	11,0	88,6	11,9	73,0	-	74
76	6,1	140,0	7,3	111,0	8,8	87,0	9,6	71,5	-	76
78	-	135,0	5,3	109,0	6,8	85,5	7,6	70,2	-	78
80	-	130,0	-	107,5	-	84,0	5,6	69,0	-	80
82	-	125,0	-	106,0	-	82,5	-	67,5	-	82
86	-	115,0	-	102,0	-	79,8	-	65,1	-	86
90	-	104,5	-	98,5	-	77,3	-	63,0	-	90
94	-	93,5	-	95,5	-	75,0	-	61,0	-	94
98	-	84,3	-	87,8	-	73,0	-	59,0	-	98
100	-	81,5	-	84,0	-	72,0	-	58,0	-	100
102	-	-	-	79,5	-	71,2	-	57,3	-	102
104	-	-	-	77,0	-	70,5	-	56,6	-	104
106	-	-	-	-	-	69,5	-	56,0	-	106
108	-	-	-	-	-	69,0	-	55,5	-	108
110	-	-	-	-	-	-	-	54,7	-	110
114	-	-	-	-	-	-	-	53,5	-	114
116	-	-	-	-	-	-	-	53,0	-	116

170-250 t 0-80 t ZB 15-24 m 15° 9,60 m 9.8 m/s 360° ISO										
102 m										
0 t 80-450t 0 t 80-450t 0 t 80-450t 0 t 80-450t										
15 m 21 m 27 m 33 m										
m	t	t	t	t	t	t	t	t	t	m
17	227,0	250,0	-	-	-	-	-	-	-	17
18	214,0	250,0	-	-	-	-	-	-	-	18
19	203,0	250,0	201,0	238,0	-	-	-	-	-	19
20	192,0	250,0	191,0	238,0	-	-	-	-	-	20
21	183,2	250,0	182,5	237,5	172,0	186,0	-	-	-	21
22	174,5	250,0	174,0	237,0	166,0	186,0	-	-	-	22
23	165,7	250,0	165,5	236,5	161,0	186,0	135,0	149,0	-	23
24	157,0	250,0	157,0	236,0	156,0	186,0	135,0	149,0	-	24
26	144,0	250,0	144,0	231,0	143,5	184,0	132,5	148,0	-	26
28	131,0	250,0	131,0	226,0	131,0	182,0	130,0	147,0	-	28
30	120,5	250,0	120,5	219,0	121,0	176,0	120,5	143,5	-	30
34	100,7	250,0	102,0	205,5	103,0	164,5	103,0	135,5	-	34
38	84,7	247,5	85,2	193,0	86,7	154,0	87,7	126,5	-	38
42	71,1	241,3	70,8	181,6	72,8	144,3	73,5	118,3	-	42
46	57,5	234,0	59,5	171,0	61,5	135,0	59,5	111,0	-	46
50	47,4	225,0	49,1	162,3	51,1	127,6	51,2	104,3	-	50
54	38,3	214,6	39,9	154,3	41,7	121,0	42,9	98,5	-	54
58	30,3	202,0	31,8	147,0	33,5	115,0	34,6	93,5	-	58
62	23,9	185,3	25,2	140,3	26,9	109,0	27,8	88,8	-	62
66	18,0	170,3	19,3	134,0	20,9	103,8	21,7	84,6	-	66
70	12,8	157,0	14,0	128,0	15,5	99,5	16,2	81,0	-	70
74	8,4	145,6	9,5	123,3	10,9	95,5	11,6	77,3	-	74
76	6,3	140,0	7,3	121,0	8,7	93,5	9,4	75,5	-	76
78	-	135,0	5,4	119,0	6,7	92,0	7,4	74,0	-	78
80	-	130,0	-	116,5	-	90,2	5,4	72,7	-	80
82	-	125,0	-	114,0	-	88,5	-	71,5	-	82
86	-	117,0	-	110,6	-	85,5	-	68,8	-	86
90	-	108,3	-	107,0	-	82,6	-	66,3	-	90
94	-	99,0	-	103,0	-	80,0	-	64,0	-	94
98	-	89,3	-	93,6	-	77,6	-	62,0	-	98
102	-	79,5	-	84,6	-	75,6	-	60,2	-	102
104	-	76,5	-	80,3	-	74,8	-	59,5	-	104
106	-	-	-	76,0	-	74,0	-	58,5	-	106
108	-	-	-	72,0	-	73,0	-	58,0	-	108
110	-	-	-	-	-	71,0	-	57,2	-	110
114	-	-	-	-	-	66,5	-	56,0	-	114
116	-	-	-	-	-	64,5	-	55,5	-	116
118	-	-	-	-	-	-	-	55,0	-	118
120	-	-	-	-	-	-	-	54,5	-	120



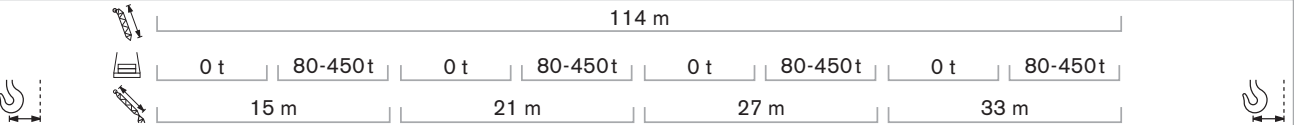
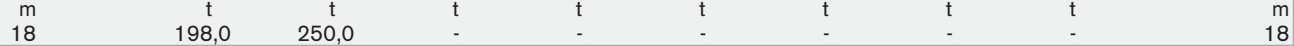

















108 m										
m	t	t	t	t	t	t	t	t	t	m
17	218,0	250,0	-	-	-	-	-	-	-	17
18	206,0	250,0	-	-	-	-	-	-	-	18
19	195,5	250,0	194,0	225,0	-	-	-	-	-	19
20	185,0	250,0	184,0	225,0	-	-	-	-	-	20
21	176,5	250,0	175,7	225,0	166,0	178,0	-	-	-	21
22	168,0	250,0	167,5	225,0	160,3	178,0	-	-	-	22
23	159,5	250,0	159,2	225,0	155,6	178,0	129,0	142,0	-	23
24	151,0	250,0	151,0	225,0	151,0	178,0	129,0	142,0	-	24
26	138,0	250,0	138,0	224,0	138,5	178,0	127,5	141,5	-	26
28	125,0	250,0	125,0	223,0	126,0	178,0	126,0	141,0	-	28
30	115,0	250,0	115,0	219,5	116,0	174,5	116,0	140,5	-	30
34	96,5	250,0	97,2	210,0	98,2	166,5	98,2	136,5	-	34
38	81,2	249,5	81,2	198,0	83,0	157,0	84,0	129,0	-	38
42	67,6	244,0	67,3	186,6	69,8	147,3	70,5	121,0	-	42
46	54,0	236,0	56,0	176,0	58,5	138,0	56,5	113,0	-	46
50	43,9	228,6	45,7	167,3	47,9	130,6	48,1	107,0	-	50
54	34,8	216,6	36,5	159,0	38,5	123,6	39,8	101,3	-	54
58	26,8	200,0	28,4	151,0	30,2	117,0	31,4	96,0	-	58
62	20,4	183,3	21,8	144,3	23,6	111,6	24,6	91,3	-	62
66	14,5	168,0	15,9	138,0	17,5	106,6	18,5	87,0	-	66
70	9,3	154,0	10,5	132,0	12,1	102,0	13,0	83,0	-	70
72	6,9	148,0	8,2	129,5	9,8	100,2	10,7	81,2	-	72
74	-	142,5	5,9	127,0	7,5	98,5	8,4	79,5	-	74
76	-	137,0	-	124,0	5,3	96,5	6,1	77,5	-	76
78	-	132,3	-	122,0	-	94,6	-	76,0	-	78
82	-	123,0	-	118,0	-	91,0	-	73,0	-	82
86	-	114,3	-	113,3	-	88,0	-	70,3	-	86
90	-	106,5	-	107,3	-	85,1	-	68,0	-	90
94	-	99,5	-	100,0	-	82,5	-	66,0	-	94
98	-	90,1	-	92,6	-	80,0	-	63,6	-	98
102	-	81,0	-	85,0	-	77,5	-	61,7	-	102
106	-	72,0	-	77,0	-	75,5	-	60,0	-	106
108	-	69,0	-	73,0	-	73,5	-	59,3	-	108
110	-	-	-	69,0	-	71,5	-	58,6	-	110
114	-	-	-	63,0	-	65,8	-	57,3	-	114
116	-	-	-	61,0	-	62,1	-	56,6	-	116
118	-	-	-	-	-	60,0	-	56,0	-	118
120	-	-	-	-	-	58,0	-	55,5	-	120
122	-	-	-	-	-	-	-	55,0	-	122
126	-	-	-	-	-	-	-	52,2	-	126
128	-	-	-	-	-	-	-	50,0	-	128

       										
114 m										
										
										
m	t	t	t	t	t	t	t	t	t	m
18	198,0	250,0	-	-	-	-	-	-	-	18
20	178,0	250,0	177,0	213,0	-	-	-	-	-	20
22	161,5	250,0	161,0	213,0	157,0	170,0	-	-	-	22
24	145,0	250,0	145,0	213,0	145,0	170,0	125,0	136,0	-	24
26	132,5	250,0	132,5	213,0	133,0	170,0	122,5	136,0	-	26
28	120,0	250,0	120,0	213,0	121,0	170,0	121,0	136,0	-	28
30	110,0	250,0	110,5	213,0	111,5	169,5	111,5	136,0	-	30
34	92,2	250,0	93,2	208,0	94,2	166,5	94,5	135,0	-	34
38	76,2	250,0	78,0	199,5	79,7	159,5	80,5	130,5	-	38
42	62,3	246,6	64,6	189,6	66,1	150,3	67,3	123,0	-	42
46	51,0	240,0	53,0	179,0	52,5	141,0	54,0	115,0	-	46
50	40,9	231,6	42,8	170,3	44,1	133,6	45,5	109,0	-	50
54	31,8	217,6	33,6	162,3	35,7	126,6	37,0	103,3	-	54
58	23,8	197,0	25,4	155,0	27,4	120,0	28,6	98,0	-	58
62	17,3	180,3	18,8	148,3	20,6	114,6	21,8	93,3	-	62
66	11,4	165,3	12,9	142,0	14,5	109,6	15,6	89,0	-	66
70	6,2	152,0	7,5	136,0	9,1	105,0	10,1	85,0	-	70
72	-	146,3	5,1	133,0	6,7	103,0	7,7	83,2	-	72
74	-	140,6	-	130,5	-	101,0	5,3	81,5	-	74
78	-	130,0	-	125,6	-	97,1	-	78,0	-	78
82	-	120,0	-	121,0	-	93,5	-	75,0	-	82
86	-	112,0	-	113,0	-	90,1	-	72,3	-	86
90	-	104,5	-	105,3	-	87,1	-	69,8	-	90
94	-	97,5	-	98,0	-	84,5	-	67,5	-	94
98	-	89,7	-	91,5	-	81,8	-	65,5	-	98
102	-	81,5	-	84,6	-	79,5	-	63,5	-	102
106	-	73,5	-	77,0	-	77,5	-	61,5	-	106
110	-	65,5	-	69,6	-	72,1	-	59,8	-	110
112	-	62,0	-	66,0	-	69,5	-	59,0	-	112
114	-	-	-	62,3	-	66,1	-	58,3	-	114
118	-	-	-	56,5	-	59,5	-	57,0	-	118
120	-	-	-	55,0	-	56,2	-	55,6	-	120
122	-	-	-	-	-	53,8	-	54,3	-	122
124	-	-	-	-	-	52,0	-	53,0	-	124
126	-	-	-	-	-	-	-	50,3	-	126
130	-	-	-	-	-	-	-	47,0	-	130
132	-	-	-	-	-	-	-	45,0	-	132





















120 m										
m	t	t	t	t	t	t	t	t	t	m
18	191,0	241,0	-	-	-	-	-	-	-	18
20	171,0	241,0	171,0	201,0	-	-	-	-	-	20
22	155,0	241,0	155,0	201,0	151,0	161,0	-	-	-	22
24	139,0	241,0	139,0	201,0	140,0	161,0	120,0	130,0	-	24
26	126,5	241,0	127,0	201,0	128,0	161,0	117,5	130,0	-	26
28	114,0	241,0	115,0	201,0	116,0	161,0	116,0	130,0	-	28
30	104,7	241,0	105,7	201,0	106,7	161,0	107,0	130,0	-	30
34	87,7	241,0	88,7	200,0	89,7	161,0	90,2	130,0	-	34
38	72,2	239,0	74,0	197,5	75,7	158,5	76,2	129,0	-	38
42	58,9	236,0	60,3	191,3	62,8	152,0	63,6	124,6	-	42
46	47,9	234,0	46,9	182,0	49,4	144,0	51,0	118,0	-	46
50	37,5	227,6	38,5	174,0	40,8	136,6	40,5	111,3	-	50
54	28,3	215,0	30,2	166,3	32,4	129,6	32,0	105,3	-	54
58	20,2	195,0	22,0	159,0	24,1	123,0	25,4	100,0	-	58
62	13,7	178,3	15,4	151,6	17,3	117,6	18,6	95,3	-	62
66	7,8	163,0	9,3	145,0	11,2	112,5	12,4	91,0	-	66
68	5,1	156,0	6,5	142,0	8,5	110,0	9,6	89,0	-	68
70	-	149,0	-	139,0	5,8	107,0	6,8	87,0	-	70
74	-	137,6	-	133,6	-	103,0	-	83,3	-	74
78	-	127,3	-	126,6	-	99,1	-	80,0	-	78
82	-	118,0	-	118,0	-	95,5	-	77,0	-	82
86	-	109,3	-	110,0	-	92,5	-	74,0	-	86
90	-	101,5	-	102,5	-	89,5	-	71,3	-	90
94	-	94,5	-	95,5	-	86,5	-	69,0	-	94
98	-	87,8	-	89,1	-	83,8	-	67,0	-	98
102	-	80,5	-	82,5	-	80,8	-	65,0	-	102
106	-	72,5	-	75,5	-	77,5	-	63,0	-	106
110	-	65,1	-	68,5	-	71,1	-	61,3	-	110
114	-	58,0	-	61,6	-	64,8	-	59,8	-	114
118	-	53,5	-	55,0	-	58,5	-	58,5	-	118
120	-	51,5	-	52,2	-	55,5	-	57,5	-	120
122	-	-	-	50,4	-	52,5	-	54,7	-	122
124	-	-	-	48,7	-	49,6	-	52,0	-	124
126	-	-	-	-	-	47,5	-	49,3	-	126
130	-	-	-	-	-	43,8	-	44,8	-	130
132	-	-	-	-	-	41,5	-	42,9	-	132
134	-	-	-	-	-	-	-	41,0	-	134
136	-	-	-	-	-	-	-	39,2	-	136

170-250 t 0-80 t ZB 15-24 m 15° 9,60 m 9.8 m/s 360° ISO										
126 m										
0 t 80-450t 0 t 80-450t 0 t 80-450t 0 t 80-450t										
15 m 21 m 27 m 33 m										
m	t	t	t	t	t	t	t	t	t	m
19	175,0	210,0	-	-	-	-	-	-	-	19
20	166,0	210,0	-	-	-	-	-	-	-	20
21	158,2	210,0	158,0	178,0	-	-	-	-	-	21
22	150,5	210,0	150,6	178,0	-	-	-	-	-	22
23	142,7	210,0	143,3	178,0	140,0	149,0	-	-	-	23
24	135,0	210,0	136,0	178,0	136,0	149,0	-	-	-	24
25	129,2	210,0	130,0	178,0	130,2	149,0	113,0	121,0	-	25
26	123,5	210,0	124,0	178,0	124,5	149,0	111,6	121,0	-	26
28	112,0	210,0	112,0	178,0	113,0	149,0	111,0	121,0	-	28
30	102,5	210,0	103,0	177,5	104,0	149,0	103,2	121,0	-	30
34	85,5	210,0	86,2	177,0	87,5	149,0	88,0	121,0	-	34
38	70,7	209,5	72,2	177,0	73,7	149,0	74,2	121,0	-	38
42	58,0	202,3	59,3	175,6	61,2	147,6	62,0	120,3	-	42
46	47,2	195,0	46,1	173,0	48,6	145,0	50,0	119,0	-	46
50	36,8	185,0	37,7	165,0	40,0	138,3	39,6	113,0	-	50
54	27,5	179,3	29,4	158,0	31,6	132,0	31,1	107,3	-	54
58	19,5	174,0	21,2	154,0	23,2	126,0	24,5	102,0	-	58
62	13,0	167,0	14,6	145,6	16,4	120,0	17,6	97,3	-	62
66	6,9	162,0	8,5	142,0	10,2	115,0	11,4	93,0	-	66
68	-	155,5	5,7	138,0	7,4	112,5	8,6	91,0	-	68
70	-	149,0	-	136,0	-	110,0	5,8	89,0	-	70
74	-	137,0	-	133,3	-	105,3	-	85,3	-	74
78	-	126,3	-	127,3	-	101,3	-	81,8	-	78
82	-	117,0	-	118,0	-	98,0	-	78,5	-	82
86	-	109,0	-	109,3	-	94,6	-	75,8	-	86
90	-	101,2	-	101,5	-	91,5	-	73,1	-	90
94	-	94,0	-	94,5	-	88,5	-	70,5	-	94
98	-	87,6	-	88,1	-	85,8	-	68,5	-	98
102	-	81,0	-	82,0	-	82,3	-	66,5	-	102
106	-	74,0	-	76,0	-	78,0	-	64,5	-	106
110	-	67,0	-	69,6	-	72,0	-	62,8	-	110
114	-	60,2	-	63,2	-	65,8	-	61,1	-	114
118	-	54,0	-	57,0	-	59,5	-	59,5	-	118
122	-	49,4	-	51,0	-	53,7	-	55,7	-	122
124	-	47,6	-	48,0	-	51,0	-	53,0	-	124
126	-	-	-	46,1	-	48,3	-	50,4	-	126
130	-	-	-	42,3	-	43,8	-	45,4	-	130
132	-	-	-	39,9	-	41,9	-	42,8	-	132
134	-	-	-	-	-	40,0	-	41,0	-	134
136	-	-	-	-	-	38,2	-	39,5	-	136
138	-	-	-	-	-	-	-	37,7	-	138
140	-	-	-	-	-	-	-	35,9	-	140

132 m										
m	t	t	t	t	t	t	t	t	t	m
19	168,0	196,0	-	-	-	-	-	-	-	19
20	159,0	196,0	-	-	-	-	-	-	-	20
21	151,5	196,0	151,0	167,0	-	-	-	-	-	21
22	144,0	196,0	144,0	167,0	-	-	-	-	-	22
23	136,5	196,0	137,0	167,0	132,0	140,0	-	-	-	23
24	129,0	196,0	130,0	167,0	130,0	140,0	-	-	-	24
25	123,2	196,0	124,2	167,0	124,5	140,0	108,0	116,0	-	25
26	117,5	196,0	118,5	167,0	119,0	140,0	106,6	116,0	-	26
28	106,0	196,0	107,0	167,0	108,0	140,0	106,0	116,0	-	28
30	97,0	196,0	98,0	167,0	99,2	140,0	98,5	116,0	-	30
34	80,7	195,5	81,7	167,0	83,0	140,0	83,7	115,5	-	34
38	67,0	194,5	68,2	166,5	69,5	140,0	70,2	115,0	-	38
42	53,8	191,3	55,6	164,6	57,4	139,6	58,4	115,0	-	42
46	40,5	186,0	42,8	162,0	45,4	139,0	47,3	115,0	-	46
50	32,3	179,6	34,4	159,3	34,9	137,0	36,6	113,0	-	50
54	24,1	170,3	26,0	150,3	26,4	133,3	27,9	109,3	-	54
58	16,0	167,0	17,8	147,0	19,9	128,0	21,3	104,0	-	58
62	9,4	159,0	11,1	139,6	13,1	122,0	14,4	99,3	-	62
64	6,2	157,0	7,8	138,0	9,8	120,0	11,0	97,0	-	64
66	-	153,3	-	135,3	6,9	117,3	8,1	94,7	-	66
68	-	149,6	-	132,6	-	114,6	5,2	92,5	-	68
70	-	146,0	-	131,0	-	112,0	-	90,5	-	70
74	-	134,6	-	128,3	-	108,0	-	86,8	-	74
78	-	124,0	-	123,0	-	104,0	-	83,5	-	78
82	-	114,0	-	115,0	-	100,0	-	80,5	-	82
86	-	106,0	-	107,0	-	96,6	-	77,5	-	86
90	-	98,5	-	99,3	-	93,5	-	74,6	-	90
94	-	91,5	-	92,0	-	90,5	-	72,0	-	94
98	-	85,1	-	85,6	-	85,8	-	70,0	-	98
102	-	78,6	-	79,5	-	80,6	-	68,0	-	102
106	-	72,0	-	73,5	-	75,0	-	66,0	-	106
110	-	65,3	-	67,1	-	69,3	-	64,0	-	110
114	-	58,8	-	61,0	-	63,5	-	61,6	-	114
118	-	52,5	-	55,0	-	57,5	-	59,0	-	118
122	-	46,7	-	49,5	-	52,1	-	53,6	-	122
126	-	42,6	-	44,0	-	46,9	-	48,5	-	126
128	-	41,0	-	41,2	-	44,3	-	46,0	-	128
130	-	-	-	39,6	-	41,7	-	43,6	-	130
134	-	-	-	35,8	-	37,9	-	38,8	-	134
136	-	-	-	33,9	-	36,4	-	36,8	-	136
138	-	-	-	-	-	34,3	-	35,2	-	138
140	-	-	-	-	-	32,3	-	33,6	-	140
142	-	-	-	-	-	-	-	32,1	-	142
146	-	-	-	-	-	-	-	27,7	-	146
148	-	-	-	-	-	-	-	25,6	-	148

       										
138 m										
       										
   										
m	t	t	t	t	t	t	t	t	t	m
20	153,0	183,0	-	-	-	-	-	-	-	20
22	138,5	183,0	138,0	157,0	-	-	-	-	-	22
24	124,0	183,0	125,0	157,0	123,0	132,0	-	-	-	24
26	112,5	183,0	113,5	157,0	113,0	132,0	103,0	110,0	-	26
28	101,0	183,0	102,0	157,0	104,0	132,0	102,0	110,0	-	28
30	92,2	182,0	93,5	157,0	95,0	132,0	94,0	110,0	-	30
34	76,2	180,5	77,5	156,0	78,7	132,0	79,7	110,0	-	34
38	63,0	179,0	64,0	154,0	65,5	132,0	66,5	109,5	-	38
42	50,5	176,6	51,9	152,0	53,8	131,3	55,2	109,0	-	42
46	37,5	174,0	39,9	150,0	42,6	130,0	44,6	109,0	-	46
50	29,2	165,6	31,4	147,3	32,0	127,3	33,8	108,3	-	50
54	21,0	159,0	23,0	141,0	23,5	125,0	25,1	107,3	-	54
58	12,9	155,0	14,8	137,0	17,0	123,0	18,5	106,0	-	58
62	6,2	149,5	7,9	134,0	10,2	117,6	11,6	101,0	-	62
64	-	146,0	-	129,0	6,8	115,0	8,2	98,5	-	64
66	-	144,0	-	127,3	-	113,6	5,2	96,5	-	66
70	-	140,0	-	124,0	-	111,0	-	92,5	-	70
74	-	130,6	-	119,3	-	105,3	-	88,8	-	74
78	-	121,3	-	116,3	-	102,6	-	85,3	-	78
82	-	112,0	-	113,0	-	100,0	-	82,0	-	82
86	-	103,7	-	104,0	-	97,5	-	79,0	-	86
90	-	96,0	-	96,5	-	94,5	-	76,1	-	90
94	-	89,0	-	89,5	-	90,5	-	73,5	-	94
98	-	82,3	-	83,1	-	84,1	-	71,1	-	98
102	-	76,0	-	77,0	-	78,1	-	69,0	-	102
106	-	70,0	-	71,0	-	72,5	-	67,0	-	106
110	-	63,5	-	65,0	-	67,0	-	65,2	-	110
114	-	57,5	-	59,1	-	61,1	-	61,8	-	114
118	-	51,5	-	53,5	-	55,5	-	56,5	-	118
122	-	45,8	-	48,1	-	50,3	-	51,5	-	122
126	-	40,3	-	42,8	-	45,2	-	46,6	-	126
130	-	36,3	-	37,6	-	40,2	-	41,8	-	130
134	-	32,3	-	33,5	-	35,4	-	37,1	-	134
136	-	30,3	-	32,0	-	33,5	-	34,9	-	136
138	-	-	-	30,1	-	31,9	-	32,7	-	138
140	-	-	-	28,3	-	30,3	-	31,0	-	140
142	-	-	-	-	-	28,7	-	29,4	-	142
146	-	-	-	-	-	24,6	-	26,2	-	146
148	-	-	-	-	-	22,4	-	24,6	-	148
150	-	-	-	-	-	-	-	22,5	-	150
152	-	-	-	-	-	-	-	20,5	-	152

144 m										
m	t	t	t	t	t	t	t	t	t	m
20	147,0	169,0	-	-	-	-	-	-	-	20
22	132,5	169,0	132,0	147,0	-	-	-	-	-	22
24	118,0	169,0	119,0	147,0	116,0	124,0	-	-	-	24
26	107,2	168,5	108,2	146,5	106,5	124,0	-	-	-	26
27	101,8	168,2	102,8	146,2	102,7	124,0	98,0	104,0	-	27
28	96,5	168,0	97,5	146,0	99,0	124,0	97,0	104,0	-	28
30	87,7	167,5	88,7	145,5	90,5	124,0	89,5	104,0	-	30
34	71,7	166,5	73,0	144,5	74,7	124,0	75,5	104,0	-	34
38	58,5	165,0	60,0	143,0	61,5	123,5	62,5	104,0	-	38
42	46,3	163,0	48,2	141,0	50,1	122,3	51,5	103,6	-	42
46	34,0	161,0	36,6	139,0	39,5	121,0	41,6	103,0	-	46
50	25,8	154,3	26,2	137,0	28,9	119,0	30,8	103,0	-	50
54	17,6	150,6	17,8	133,3	20,3	117,0	21,2	102,0	-	54
58	9,4	146,0	11,4	128,0	13,7	115,0	12,8	100,0	-	58
60	5,9	143,3	7,8	126,6	10,2	113,5	10,5	99,0	-	60
62	-	141,6	-	125,3	6,7	112,0	8,2	98,0	-	62
66	-	135,0	-	119,6	-	106,6	-	96,0	-	66
70	-	131,0	-	117,0	-	104,0	-	94,0	-	70
74	-	125,6	-	112,3	-	99,6	-	89,0	-	74
78	-	118,3	-	110,0	-	97,5	-	86,5	-	78
82	-	109,0	-	108,0	-	95,5	-	83,5	-	82
86	-	100,6	-	101,0	-	92,0	-	80,5	-	86
90	-	92,8	-	93,8	-	90,0	-	77,6	-	90
94	-	85,5	-	86,5	-	88,0	-	75,0	-	94
98	-	79,1	-	79,8	-	81,6	-	72,6	-	98
102	-	73,0	-	73,5	-	75,5	-	70,5	-	102
106	-	67,0	-	68,0	-	69,5	-	68,5	-	106
110	-	60,6	-	62,0	-	63,5	-	63,8	-	110
114	-	54,7	-	56,1	-	57,8	-	58,8	-	114
118	-	49,2	-	50,5	-	52,5	-	53,5	-	118
122	-	43,8	-	45,5	-	47,5	-	48,5	-	122
126	-	38,5	-	40,5	-	42,6	-	43,7	-	126
130	-	33,4	-	35,6	-	37,9	-	39,2	-	130
134	-	30,2	-	30,8	-	33,3	-	34,8	-	134
138	-	26,5	-	27,6	-	28,9	-	30,5	-	138
140	-	24,2	-	25,9	-	27,0	-	28,4	-	140
142	-	-	-	24,2	-	25,5	-	26,3	-	142
144	-	-	-	22,3	-	23,9	-	24,2	-	144
146	-	-	-	-	-	22,4	-	22,7	-	146
150	-	-	-	-	-	18,8	-	19,7	-	150
152	-	-	-	-	-	16,8	-	18,2	-	152
154	-	-	-	-	-	-	-	16,8	-	154
156	-	-	-	-	-	-	-	15,0	-	156

       										
150 m										
       										
   										
m	t	t	t	t	t	t	t	t	t	m
21	133,0	155,0	-	-	-	-	-	-	-	21
22	126,3	155,0	-	-	-	-	-	-	-	22
23	119,6	155,0	120,0	135,0	-	-	-	-	-	23
24	113,0	155,0	114,0	135,0	-	-	-	-	-	24
25	107,6	155,0	108,7	134,7	107,0	117,0	-	-	-	25
26	102,2	155,0	103,5	134,5	102,1	117,0	-	-	-	26
27	96,8	155,0	98,2	134,2	98,3	117,0	92,5	98,0	-	27
28	91,5	155,0	93,0	134,0	94,5	117,0	91,5	98,0	-	28
30	83,0	154,5	84,5	133,5	86,0	116,5	84,7	98,0	-	30
34	67,5	153,0	69,0	132,5	70,5	115,5	71,5	98,0	-	34
38	54,6	151,5	56,0	131,5	57,7	114,5	58,7	98,0	-	38
42	42,8	150,0	44,5	130,0	46,8	113,3	48,2	97,8	-	42
46	31,0	148,0	33,7	128,0	36,6	112,0	38,6	97,5	-	46
50	22,7	146,0	23,3	126,0	26,0	110,0	28,0	96,1	-	50
54	14,5	140,0	14,8	124,0	17,4	108,3	18,4	94,6	-	54
58	6,3	137,0	8,4	122,0	10,8	107,0	10,0	93,0	-	58
60	-	132,6	-	117,6	7,1	106,0	7,6	92,5	-	60
62	-	131,3	-	116,3	-	104,5	5,3	91,5	-	62
66	-	127,0	-	112,0	-	99,8	-	89,5	-	66
70	-	123,0	-	109,0	-	97,5	-	87,5	-	70
74	-	119,0	-	106,3	-	95,5	-	85,5	-	74
78	-	115,0	-	103,0	-	91,5	-	81,6	-	78
82	-	106,0	-	101,0	-	89,5	-	80,0	-	82
86	-	97,6	-	96,6	-	86,3	-	76,3	-	86
90	-	89,8	-	90,8	-	84,6	-	74,6	-	90
94	-	82,5	-	83,5	-	83,0	-	73,0	-	94
98	-	76,1	-	76,8	-	78,0	-	70,6	-	98
102	-	70,0	-	70,5	-	72,3	-	69,2	-	102
106	-	64,0	-	64,5	-	66,0	-	66,0	-	106
110	-	58,0	-	58,8	-	60,3	-	60,6	-	110
114	-	52,2	-	53,4	-	54,9	-	55,5	-	114
118	-	46,8	-	48,2	-	49,8	-	50,5	-	118
122	-	41,5	-	43,1	-	44,8	-	45,7	-	122
126	-	36,5	-	38,3	-	40,1	-	41,0	-	126
130	-	31,7	-	33,6	-	35,5	-	36,6	-	130
134	-	27,1	-	29,0	-	31,1	-	32,3	-	134
138	-	23,7	-	24,6	-	26,9	-	28,2	-	138
142	-	20,4	-	21,2	-	22,8	-	24,2	-	142
144	-	18,5	-	19,7	-	20,7	-	22,2	-	144
146	-	-	-	18,2	-	19,2	-	20,3	-	146
150	-	-	-	14,7	-	16,2	-	16,6	-	150
152	-	-	-	12,7	-	14,7	-	15,2	-	152
154	-	-	-	-	-	13,3	-	13,9	-	154
156	-	-	-	-	-	11,6	-	12,6	-	156
158	-	-	-	-	-	-	-	11,2	-	158
162	-	-	-	-	-	-	-	8,1	-	162
164	-	-	-	-	-	-	-	6,4	-	164

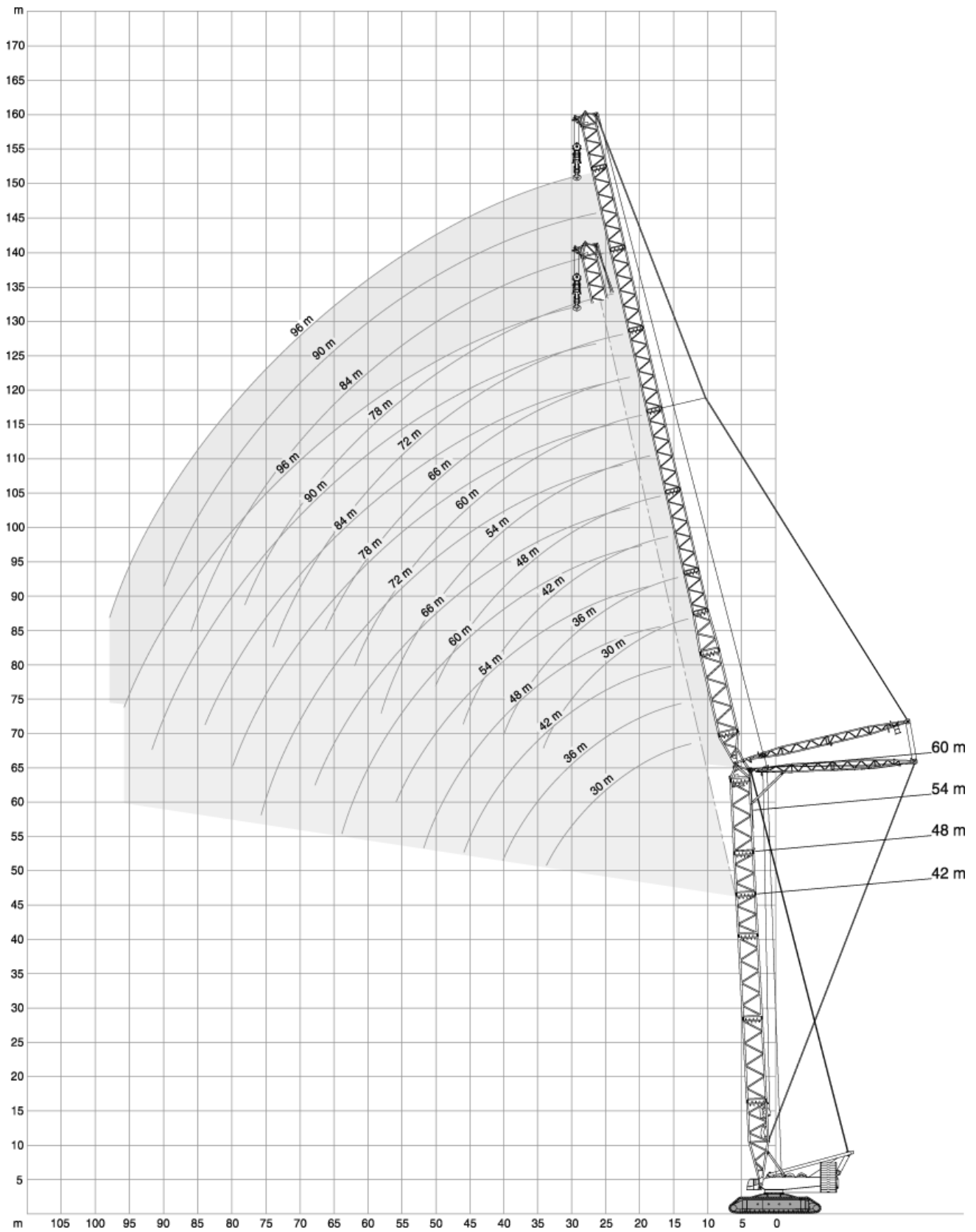

170-250 t 0-80 t ZB 9,60 m 9.8 m/s 360° ISO

42 m																			
		30 m			36 m			42 m			48 m			54 m			60 m		
		87°	75°	65°	87°	75°	65°	87°	75°	65°	87°	75°	65°	87°	75°	65°	87°	75°	65°
m	t	t	t	t	t	t	t	t	t	t	t	t	t	t	t	t	t	t	t
14	339,0	-	-	-	-	-	-	-	-	-	-	-	-	-	-	-	-	-	-
15	317,0	-	-	-	305,0	-	-	-	-	-	-	-	-	-	-	-	-	-	-
16	297,0	-	-	-	286,0	-	-	277,0	-	-	-	-	-	-	-	-	-	-	-
18	265,0	-	-	-	256,0	-	-	247,0	-	-	239,0	-	-	-	-	-	-	-	-
19	251,0	-	-	-	242,0	-	-	235,0	-	-	227,0	-	-	220,0	-	-	-	-	-
20	238,0	-	-	-	230,0	-	-	223,0	-	-	216,0	-	-	209,0	-	-	202,0	-	-
22	217,0	-	-	-	209,0	-	-	203,0	-	-	197,0	-	-	191,0	-	-	184,0	-	-
24	198,0	-	-	-	192,0	-	-	186,0	-	-	180,0	-	-	175,0	-	-	169,0	-	-
26	183,0	-	-	-	177,0	-	-	172,0	-	-	166,0	-	-	161,0	-	-	156,0	-	-
28	166,0	145,0	-	-	164,0	-	-	159,0	-	-	154,0	-	-	150,0	-	-	145,0	-	-
30	151,0	132,0	-	-	151,0	-	-	148,0	-	-	143,0	-	-	139,0	-	-	135,0	-	-
32	138,0	120,0	-	-	138,0	119,0	-	138,0	-	-	134,0	-	-	130,0	-	-	126,0	-	-
34	127,0	111,0	-	-	127,0	110,0	-	127,0	109,0	-	125,0	-	-	122,0	-	-	118,0	-	-
36	-	102,0	-	-	118,0	101,0	-	117,0	100,0	-	116,0	98,5	-	114,0	-	-	111,0	-	-
38	-	95,0	-	-	109,0	94,0	-	109,0	93,5	-	107,0	91,0	-	107,0	89,5	-	104,0	-	-
40	-	88,5	77,5	-	99,5*	87,5	-	102,0	87,0	-	100,0	84,5	-	99,5	84,0	-	98,5	-	-
42	-	83,0	72,0	-	-	82,0	-	95,0	81,0	-	93,5	79,0	-	93,0	78,0	-	93,0	76,0	-
44	-	-	67,5	-	-	76,5	66,0	89,5	76,0	-	88,0	74,0	-	87,0	73,0	-	87,0	71,5	-
46	-	-	63,5	-	-	72,0	62,0	82,0*	71,0	-	82,5	69,0	-	82,0	68,5	-	81,5	67,5	-
48	-	-	59,5	-	-	68,0	58,5	-	67,0	57,0	77,5	65,0	-	77,0	64,0	-	77,0	63,5	-
50	-	-	56,0	-	-	-	55,0	-	63,0	53,5	73,5	61,0	51,0	72,5	60,5	-	72,5	59,5	-
54	-	-	-	-	-	-	48,7	-	56,5	47,5	-	54,5	44,9	65,0	53,5	43,6	64,5	53,0	-
58	-	-	-	-	-	-	-	-	-	42,3	-	49,1	39,7	57,0*	48,2	38,5	58,0	47,6	37,5
62	-	-	-	-	-	-	-	-	-	-	-	-	35,3	-	43,3	34,1	52,5	42,5	33,1
66	-	-	-	-	-	-	-	-	-	-	-	-	31,6	-	39,0	30,3	-	38,0	29,3
70	-	-	-	-	-	-	-	-	-	-	-	-	-	-	27,0	-	-	34,2	25,9
74	-	-	-	-	-	-	-	-	-	-	-	-	-	-	-	-	-	-	23,0
78	-	-	-	-	-	-	-	-	-	-	-	-	-	-	-	-	-	-	20,4

42 m																			
		66 m			72 m			78 m			84 m			90 m			96 m		
		87°	75°	65°	87°	75°	65°	87°	75°	65°	87°	75°	65°	87°	75°	65°	87°	75°	65°
m	t	t	t	t	t	t	t	t	t	t	t	t	t	t	t	t	t	t	t
22	178,0	-	-	-	-	-	-	-	-	-	-	-	-	-	-	-	-	-	-
24	163,0	-	-	-	158,0	-	-	154,0	-	-	-	-	-	-	-	-	-	-	-
26	151,0	-	-	-	146,0	-	-	142,0	-	-	137,0	-	-	-	-	-	-	-	-
28	140,0	-	-	-	135,0	-	-	132,0	-	-	127,0	-	-	124,0	-	-	114,0	-	-
30	130,0	-	-	-	126,0	-	-	123,0	-	-	118,0	-	-	115,0	-	-	111,0	-	-
34	113,0	-	-	-	110,0	-	-	107,0	-	-	103,0	-	-	100,0	-	-	97,0	-	-
38	100,0	-	-	-	97,0	-	-	94,5	-	-	91,0	-	-	88,5	-	-	85,0	-	-
42	89,0	-	-	-	86,0	-	-	84,0	-	-	81,0	-	-	78,5	-	-	75,5	-	-
44	84,5	67,5	-	-	81,5	-	-	79,5	-	-	76,5	-	-	74,0	-	-	71,0	-	-
46	80,0	64,0	-	-	77,0	61,0	-	75,0	-	-	72,0	-	-	70,0	-	-	67,0	-	-
50	71,0	57,0	-	-	69,5	54,0	-	67,5	52,5	-	64,5	-	-	62,5	-	-	60,0	-	-
54	63,5	51,5	-	-	62,0	48,7	-	61,0	47,0	-	58,0	44,1	-	56,5	42,2	-	53,5	-	-
58	57,0	45,9	-	-	55,5	43,7	-	55,0	42,2	-	52,5	39,3	-	51,0	37,5	-	48,3	34,7	-
62	51,0	40,8	31,2	-	50,0	38,9	-	49,5	37,9	-	47,8	35,1	-	46,1	33,4	-	43,5	30,6	-
66	46,5	36,3	27,4	-	45,2	34,4	25,3	44,6	33,5	-	43,4	31,4	-	41,7	29,7	-	39,2	27,0	-
70	40,7*	32,4	24,0	-	40,9	30,6	22,0	40,3	29,7	20,9	39,2	28,0	-	37,9	26,4	-	35,4	23,8	-
74	-	29,0	21,1	-	37,2	27,1	19,0	36,6	26,3	18,0	35,2	24,7	16,2	34,3	23,5	14,9	32,0	20,9	-
78	-	-	18,5	-	-	24,1	16,4	33,1	23,2	15,4	31,7	21,6	13,6	30,7	20,5	12,4	28,8	18,3	10,1
82	-	-	16,1	-	-	21,4	14,1	28,3*	20,6	13,1	28,5	18,9	11,4	27,5	17,8	10,1	26,0	15,9	8,0
86	-	-	-	-	-	-	12,1	-	18,2	11,1	25,6	16,5	9,3	24,6	15,4	8,1	23,3	13,7	6,1
90	-	-	-	-	-	-	10,3	-	-	9,2	-	14,4	7,5	22,0	13,2	6,2	20,6	11,7	-
94	-	-	-	-	-	-	-	-	-	7,6	-	12,4	5,8	-	11,3	-	18,3	9,7	-
98	-	-	-	-	-	-	-	-	-	-	-	-	-	-	9,5	-	14,8*	7,9	-
102	-	-	-	-	-	-	-	-	-	-	-	-	-	-	-	-	-	6,3	-

For explanations see page 42 · Bemerkungen siehe Seite 42 · Pour plus de détails, voir page 42 · Per spiegazioni vedere a pagina 42 · Véase p. 42 para más información · Para explicações, ver página 42 · Объяснения см. на стр. 42

170-250 t 0-80 t ZB 9,60 m 9.8 m/s 360° ISO

48 m																			
		30 m			36 m			42 m			48 m			54 m			60 m		
		87°	75°	65°	87°	75°	65°	87°	75°	65°	87°	75°	65°	87°	75°	65°	87°	75°	65°
m	t	t	t	t	t	t	t	t	t	t	t	t	t	t	t	t	t	t	t
14	324,0	-	-	-	-	-	-	-	-	-	-	-	-	-	-	-	-	-	-
15	304,0	-	-	-	292,0	-	-	-	-	-	-	-	-	-	-	-	-	-	-
16	286,0	-	-	-	275,0	-	-	-	-	-	-	-	-	-	-	-	-	-	-
17	270,0	-	-	-	260,0	-	-	251,0	-	-	-	-	-	-	-	-	-	-	-
18	255,0	-	-	-	246,0	-	-	238,0	-	-	230,0	-	-	-	-	-	-	-	-
19	242,0	-	-	-	234,0	-	-	226,0	-	-	219,0	-	-	212,0	-	-	-	-	-
20	230,0	-	-	-	222,0	-	-	215,0	-	-	208,0	-	-	202,0	-	-	-	-	-
22	209,0	-	-	-	202,0	-	-	196,0	-	-	190,0	-	-	184,0	-	-	178,0	-	-
24	192,0	-	-	-	186,0	-	-	180,0	-	-	174,0	-	-	169,0	-	-	164,0	-	-
26	177,0	-	-	-	171,0	-	-	166,0	-	-	161,0	-	-	156,0	-	-	151,0	-	-
28	164,0	-	-	-	159,0	-	-	154,0	-	-	149,0	-	-	145,0	-	-	140,0	-	-
30	150,0	126,0	-	-	148,0	-	-	144,0	-	-	139,0	-	-	135,0	-	-	130,0	-	-
32	138,0	116,0	-	-	138,0	113,0	-	134,0	-	-	130,0	-	-	126,0	-	-	122,0	-	-
34	127,0	107,0	-	-	127,0	106,0	-	126,0	-	-	122,0	-	-	118,0	-	-	114,0	-	-
36	114,0*	99,0	-	-	117,0	98,0	-	117,0	96,0	-	115,0	-	-	111,0	-	-	107,0	-	-
38	-	91,5	-	-	109,0	90,5	-	108,0	89,5	-	107,0	86,5	-	105,0	-	-	101,0	-	-
40	-	85,5	-	-	101,0	84,5	-	101,0	83,5	-	99,5	81,5	-	99,0	78,5	-	95,5	-	-
42	-	79,5	67,0	-	-	78,5	-	94,5	78,0	-	93,0	75,5	-	92,5	74,0	-	90,5	70,5	-
44	-	74,5	62,5	-	-	73,5	-	88,5	73,0	-	87,0	70,5	-	86,5	70,0	-	85,5	66,5	-
46	-	-	58,0	-	-	69,0	56,5	83,5	68,5	-	82,0	66,0	-	81,5	65,5	-	81,0	62,5	-
50	-	-	51,0	-	-	61,5	49,8	-	60,5	48,5	73,0	58,5	-	72,0	57,5	-	72,0	56,0	-
54	-	-	-	-	-	-	44,0	-	54,0	42,7	-	52,0	40,0	64,5	51,0	-	64,5	50,5	-
58	-	-	-	-	-	-	39,1	-	-	37,8	-	46,6	35,1	56,0*	45,5	33,9	57,5	44,9	-
62	-	-	-	-	-	-	-	-	-	33,6	-	-	31,0	-	40,6	29,8	52,0	39,9	28,8
66	-	-	-	-	-	-	-	-	-	-	-	-	27,5	-	36,4	26,2	-	35,6	25,3
70	-	-	-	-	-	-	-	-	-	-	-	-	-	-	-	23,2	-	31,9	22,2
74	-	-	-	-	-	-	-	-	-	-	-	-	-	-	-	20,5	-	-	19,4
78	-	-	-	-	-	-	-	-	-	-	-	-	-	-	-	-	-	-	17,0

48 m																			
		66 m			72 m			78 m			84 m			90 m			96 m		
		87°	75°	65°	87°	75°	65°	87°	75°	65°	87°	75°	65°	87°	75°	65°	87°	75°	65°
m	t	t	t	t	t	t	t	t	t	t	t	t	t	t	t	t	t	t	t
22	172,0	-	-	-	-	-	-	-	-	-	-	-	-	-	-	-	-	-	-
24	158,0	-	-	-	153,0	-	-	-	-	-	-	-	-	-	-	-	-	-	-
26	146,0	-	-	-	141,0	-	-	137,0	-	-	133,0	-	-	-	-	-	-	-	-
28	135,0	-	-	-	131,0	-	-	127,0	-	-	123,0	-	-	120,0	-	-	-	-	-
30	126,0	-	-	-	122,0	-	-	119,0	-	-	114,0	-	-	111,0	-	-	107,0	-	-
34	110,0	-	-	-	106,0	-	-	104,0	-	-	100,0	-	-	97,5	-	-	93,5	-	-
38	97,0	-	-	-	94,0	-	-	91,5	-	-	88,0	-	-	85,5	-	-	82,5	-	-
42	86,5	-	-	-	83,5	-	-	81,5	-	-	78,0	-	-	76,0	-	-	73,0	-	-
46	77,5	59,0	-	-	74,5	-	-	73,0	-	-	69,5	-	-	67,5	-	-	64,5	-	-
48	73,5	55,5	-	-	71,0	52,5	-	69,0	-	-	66,0	-	-	64,0	-	-	61,0	-	-
50	70,0	52,5	-	-	67,0	49,8	-	65,5	48,0	-	62,5	-	-	60,5	-	-	57,5	-	-
54	63,0	47,3	-	-	60,5	44,5	-	59,0	42,8	-	56,5	39,8	-	54,5	-	-	51,5	-	-
58	56,5	42,5	-	-	55,0	39,8	-	53,5	38,2	-	51,0	35,3	-	49,3	33,5	-	46,6	30,7	-
62	51,0	38,2	-	-	49,8	35,7	-	48,8	34,2	-	46,2	31,4	-	44,5	29,6	-	41,9	26,9	-
66	46,2	33,9	23,4	-	44,9	32,0	21,2	44,3	30,6	-	41,9	27,8	-	40,3	26,2	-	37,7	23,5	-
70	40,2*	30,2	20,2	-	40,6	28,2	18,1	40,0	27,3	17,0	38,1	24,7	-	36,5	23,1	-	34,0	20,5	-
74	-	26,8	17,5	-	36,9	25,0	15,4	36,2	24,0	14,3	34,6	21,9	12,1	33,1	20,3	-	30,6	17,7	-
78	-	23,9	15,1	-	-	22,0	13,0	32,7	21,1	11,9	31,3	19,3	9,9	30,0	17,8	-	27,6	15,2	-
82	-	-	12,9	-	-	19,4	10,8	27,7*	18,5	9,8	28,1	16,9	8,0	27,1	15,5	-	24,8	13,0	-
86	-	-	11,0	-	-	-	8,9	-	16,2	7,9	25,3	14,6	6,1	24,3	13,4	-	22,3	10,9	-
90	-	-	-	-	-	-	7,2	-	14,2	6,2	-	12,5	-	21,7	11,4	-	20,0	9,0	-
94	-	-	-	-	-	-	-	-	-	-	-	10,6	-	17,7*	9,5	-	17,9	7,3	-
98	-	-	-	-	-	-	-	-	-	-	-	-	-	-	7,8	-	15,9	5,7	-
102	-	-	-	-	-	-	-	-	-	-	-	-	-	-	6,3	-	-	-	-

For explanations see page 42 · Bemerkungen siehe Seite 42 · Pour plus de détails, voir page 42 · Per spiegazioni vedere a pagina 42 · Véase p. 42 para más información · Para explicações, ver página 42 · Объяснения см. на стр. 42

170-250 t 0-80 t ZB 9,60 m 9.8 m/s 360° ISO

54 m

m	30 m			36 m			42 m			48 m			54 m			60 m		
	87°	75°	65°	87°	75°	65°	87°	75°	65°	87°	75°	65°	87°	75°	65°	87°	75°	65°
14	t	t	t	t	t	t	t	t	t	t	t	t	t	t	t	t	t	t
16	310,0	-	-	-	-	-	-	-	-	-	-	-	-	-	-	-	-	-
17	274,0	-	-	264,0	-	-	-	-	-	-	-	-	-	-	-	-	-	-
18	259,0	-	-	250,0	-	-	242,0	-	-	-	-	-	-	-	-	-	-	-
20	246,0	-	-	237,0	-	-	229,0	-	-	221,0	-	-	-	-	-	-	-	-
22	222,0	-	-	214,0	-	-	208,0	-	-	201,0	-	-	195,0	-	-	-	-	-
24	202,0	-	-	196,0	-	-	190,0	-	-	183,0	-	-	178,0	-	-	172,0	-	-
26	186,0	-	-	180,0	-	-	174,0	-	-	169,0	-	-	164,0	-	-	158,0	-	-
28	172,0	-	-	166,0	-	-	161,0	-	-	156,0	-	-	151,0	-	-	146,0	-	-
30	159,0	-	-	154,0	-	-	150,0	-	-	145,0	-	-	140,0	-	-	136,0	-	-
32	149,0	-	-	143,0	-	-	139,0	-	-	135,0	-	-	131,0	-	-	126,0	-	-
34	137,0	110,0	-	134,0	-	-	130,0	-	-	126,0	-	-	122,0	-	-	118,0	-	-
36	126,0	103,0	-	126,0	99,0	-	122,0	-	-	118,0	-	-	115,0	-	-	111,0	-	-
38	113,0*	95,0	-	116,0	93,0	-	115,0	89,5	-	111,0	-	-	108,0	-	-	104,0	-	-
40	-	88,0	-	108,0	87,0	-	108,0	84,0	-	105,0	-	-	102,0	-	-	98,5	-	-
42	-	82,0	-	101,0	81,0	-	100,0	79,5	-	99,0	75,5	-	96,5	-	-	92,5	-	-
44	-	76,5	-	91,0*	75,5	-	94,0	74,5	-	92,5	71,5	-	91,0	68,5	-	87,5	-	-
46	-	71,5	-	-	70,5	-	88,0	69,5	-	86,5	67,5	-	86,0	64,5	-	83,0	61,0	-
48	-	67,0	52,5	-	66,0	-	83,0	65,0	-	81,5	63,0	-	81,0	61,0	-	79,0	57,5	-
50	-	-	49,2	-	62,0	47,7	75,0*	61,5	-	76,5	59,0	-	76,0	58,0	-	75,0	54,5	-
54	-	-	46,0	-	58,5	44,5	-	57,5	-	72,0	55,5	-	71,5	54,5	-	71,5	51,5	-
58	-	-	40,5	-	-	39,1	-	51,5	37,7	62,0*	49,2	-	64,0	48,1	-	64,0	46,5	-
62	-	-	-	-	-	34,5	-	-	33,1	-	43,6	30,4	55,0*	42,6	29,1	57,5	41,9	-
66	-	-	-	-	-	-	-	-	29,3	-	39,0	26,6	-	37,9	25,3	51,5	37,2	24,4
70	-	-	-	-	-	-	-	-	26,0	-	-	23,3	-	33,8	22,0	-	33,1	21,1
74	-	-	-	-	-	-	-	-	-	-	-	20,5	-	-	19,2	-	29,5	18,3
78	-	-	-	-	-	-	-	-	-	-	-	-	-	-	16,7	-	26,4	15,7
82	-	-	-	-	-	-	-	-	-	-	-	-	-	-	14,7	-	-	13,5
86	-	-	-	-	-	-	-	-	-	-	-	-	-	-	-	-	-	11,6

m	66 m			72 m			78 m			84 m			90 m			96 m		
	87°	75°	65°	87°	75°	65°	87°	75°	65°	87°	75°	65°	87°	75°	65°	87°	75°	65°
22	t	t	t	t	t	t	t	t	t	t	t	t	t	t	t	t	t	t
24	166,0	-	-	-	-	-	-	-	-	-	-	-	-	-	-	-	-	-
26	152,0	-	-	147,0	-	-	-	-	-	-	-	-	-	-	-	-	-	-
28	141,0	-	-	136,0	-	-	133,0	-	-	128,0	-	-	-	-	-	-	-	-
30	131,0	-	-	126,0	-	-	123,0	-	-	119,0	-	-	116,0	-	-	-	-	-
34	122,0	-	-	118,0	-	-	115,0	-	-	111,0	-	-	107,0	-	-	103,0	-	-
38	106,0	-	-	103,0	-	-	100,0	-	-	96,5	-	-	94,0	-	-	90,5	-	-
42	94,0	-	-	91,0	-	-	88,5	-	-	85,0	-	-	83,0	-	-	79,5	-	-
46	84,0	-	-	81,0	-	-	79,0	-	-	75,5	-	-	73,5	-	-	70,0	-	-
50	75,5	-	-	72,5	-	-	70,5	-	-	67,5	-	-	65,5	-	-	62,5	-	-
54	71,5	51,0	-	68,5	-	-	67,0	-	-	64,0	-	-	62,0	-	-	59,0	-	-
58	68,0	48,2	-	65,0	45,2	-	63,5	-	-	60,5	-	-	58,5	-	-	55,5	-	-
62	61,5	43,1	-	59,0	40,2	-	57,0	38,5	-	54,5	35,5	-	52,5	-	-	50,0	-	-
66	56,0	38,5	-	53,5	35,8	-	52,0	34,2	-	49,2	31,3	-	47,5	29,5	-	44,8	-	-
70	50,5	34,6	-	48,6	31,9	-	47,2	30,4	-	44,5	27,6	-	42,9	25,9	-	40,3	23,1	-
74	45,9	31,1	19,1	44,4	28,5	-	43,0	27,1	-	40,4	24,3	-	38,7	22,7	-	36,2	19,9	-
78	39,5*	27,8	16,4	40,3	25,4	13,9	39,2	24,1	-	36,6	21,4	-	35,1	19,8	-	32,6	17,1	-
82	-	24,6	13,8	36,5	22,7	11,6	35,8	21,4	10,3	33,3	18,7	-	31,7	17,2	-	29,3	14,5	-
86	-	21,8	11,6	-	19,9	9,4	32,3	18,9	8,3	30,3	16,3	-	28,7	14,8	-	26,3	12,2	-
90	-	-	9,6	-	17,4	7,5	27,0*	16,4	6,3	27,5	14,1	-	26,0	12,6	-	23,6	10,1	-
94	-	-	7,8	-	15,2	5,7	-	14,2	-	24,9	12,1	-	23,5	10,7	-	21,2	8,2	-
98	-	-	-	-	-	-	-	12,3	-	-	10,3	-	21,3	8,8	-	18,9	6,4	-
102	-	-	-	-	-	-	-	-	-	-	8,6	-	17,1*	7,2	-	16,8	-	-
106	-	-	-	-	-	-	-	-	-	-	7,0	-	-	5,6	-	15,0	-	-

For explanations see page 42 · Bemerkungen siehe Seite 42 · Pour plus de détails, voir page 42 · Per spiegazioni vedere a pagina 42 · Véase p. 42 para más información · Para explicações, ver página 42 · Объяснения см. на стр. 42

170-250 t 0-80 t ZB 9,60 m 9.8 m/s 360° ISO

60 m																				
		30 m			36 m			42 m			48 m			54 m			60 m			
		87°	75°	65°	87°	75°	65°	87°	75°	65°	87°	75°	65°	87°	75°	65°	87°	75°	65°	
m	t	t	t	t	t	t	t	t	t	t	t	t	t	t	t	t	t	t	t	
14	297,0	-	-	-	-	-	-	-	-	-	-	-	-	-	-	-	-	-	-	
16	263,0	-	-	254,0	-	-	-	-	-	-	-	-	-	-	-	-	-	-	-	
17	249,0	-	-	240,0	-	-	232,0	-	-	-	-	-	-	-	-	-	-	-	-	
18	236,0	-	-	228,0	-	-	221,0	-	-	-	-	-	-	-	-	-	-	-	-	
19	224,0	-	-	217,0	-	-	210,0	-	-	203,0	-	-	-	-	-	-	-	-	-	
20	214,0	-	-	207,0	-	-	200,0	-	-	193,0	-	-	187,0	-	-	-	-	-	-	
22	195,0	-	-	189,0	-	-	183,0	-	-	177,0	-	-	171,0	-	-	166,0	-	-	-	
24	180,0	-	-	173,0	-	-	168,0	-	-	163,0	-	-	158,0	-	-	153,0	-	-	-	
26	166,0	-	-	160,0	-	-	156,0	-	-	150,0	-	-	146,0	-	-	141,0	-	-	-	
28	154,0	-	-	149,0	-	-	145,0	-	-	140,0	-	-	136,0	-	-	131,0	-	-	-	
30	144,0	-	-	139,0	-	-	135,0	-	-	130,0	-	-	126,0	-	-	122,0	-	-	-	
34	125,0	96,0	-	122,0	-	-	119,0	-	-	114,0	-	-	111,0	-	-	107,0	-	-	-	
36	111,0*	90,0	-	115,0	86,0	-	112,0	-	-	108,0	-	-	104,0	-	-	101,0	-	-	-	
38	-	84,0	-	107,0	81,0	-	105,0	77,5	-	102,0	-	-	98,5	-	-	95,0	-	-	-	
42	-	72,5	-	90,0*	71,5	-	93,5	69,0	-	91,5	65,5	-	88,5	-	-	85,0	-	-	-	
44	-	68,0	-	-	67,0	-	87,5	65,5	-	86,0	62,0	-	84,0	59,0	-	80,5	-	-	-	
46	-	63,5	-	-	62,5	-	82,0	62,0	-	80,5	58,5	-	79,5	55,5	-	76,5	52,5	-	-	
48	-	-	43,0	-	59,0	-	74,0*	58,0	-	76,0	55,5	-	75,5	52,5	-	72,5	49,5	-	-	
50	-	-	40,1	-	55,5	-	-	54,5	-	71,5	52,0	-	71,0	50,0	-	69,0	46,8	-	-	
54	-	-	35,0	-	-	33,6	-	48,1	32,2	61,0*	45,7	-	63,5	44,6	-	63,0	41,9	-	-	
58	-	-	-	-	-	29,3	-	42,8	28,0	-	40,4	25,1	57,0	39,3	-	57,0	37,6	-	-	
62	-	-	-	-	-	25,8	-	-	24,4	-	35,9	21,6	-	34,8	20,4	51,5	33,9	-	-	
66	-	-	-	-	-	-	-	-	21,4	-	-	18,6	-	30,9	17,4	44,2*	30,3	16,5	-	
70	-	-	-	-	-	-	-	-	-	-	-	16,1	-	27,6	14,8	-	26,9	13,9	-	
74	-	-	-	-	-	-	-	-	-	-	-	13,9	-	-	12,5	-	23,8	11,6	-	
78	-	-	-	-	-	-	-	-	-	-	-	-	-	-	10,6	-	-	9,6	-	
82	-	-	-	-	-	-	-	-	-	-	-	-	-	-	-	-	-	7,8	-	
86	-	-	-	-	-	-	-	-	-	-	-	-	-	-	-	-	-	6,3	-	

66 m				
		87°	75°	65°
m	t	t	t	t
24	147,0	-	-	-
26	136,0	-	-	-
28	126,0	-	-	-
30	117,0	-	-	-
34	103,0	-	-	-
38	91,0	-	-	-
42	81,0	-	-	-
46	73,0	-	-	-
48	69,0	45,8	-	-
50	65,5	43,2	-	-
54	59,5	38,4	-	-
58	54,0	34,3	-	-
62	49,5	30,6	-	-
66	45,3	27,3	-	-
70	38,5*	24,4	11,5	-
74	-	21,7	9,4	-
78	-	19,3	7,6	-
82	-	17,0	5,9	-

* Main boom angle 85° · Hauptauslegerwinkel 85° · Jarret de flèche principale 85° · Inclinazione braccio base 85° · Ângulo de pluma principal 85° · Ângulo da lança principal 85° · Угол подъема гл. стрелы 85°

Main boom angle 87°, 85°, 75° and 65°, capacities for intermediate boom positions are calculated by the crane control system IC-1 · Hauptauslegerwinkel 87°, 85°, 75° und 65°, Traglasten für Zwischenstellungen des Hauptauslegers werden von der Kransteuerung IC-1 berechnet · Jarret de flèche principale 87°, 85°, 75° et 65°, le système de commande de la grue IC-1 calcule les charges pour les positions intermédiaires de la flèche · Inclinazione braccio base 87°, 85°, 75° e 65°, capacità per posizioni intermedie del braccio sono calcolate dal sistema di controllo della gru IC-1 · Ângulo de pluma principal 87°, 85°, 75° y 65°, las capacidades para posiciones de pluma intermedias son calculadas por el sistema de control de grúa IC-1 · Ângulos da lança principal 87°, 85°, 75° e 65°, as capacidades para posições da lança intermediária são calculadas pelo sistema de controle da grua IC-1 · Грузоподъемность при углах подъема главной стрелы 87°, 85°, 75° и 65°, грузоподъемность в промежуточных положениях стрелы рассчитывается системой управления краном IC-1

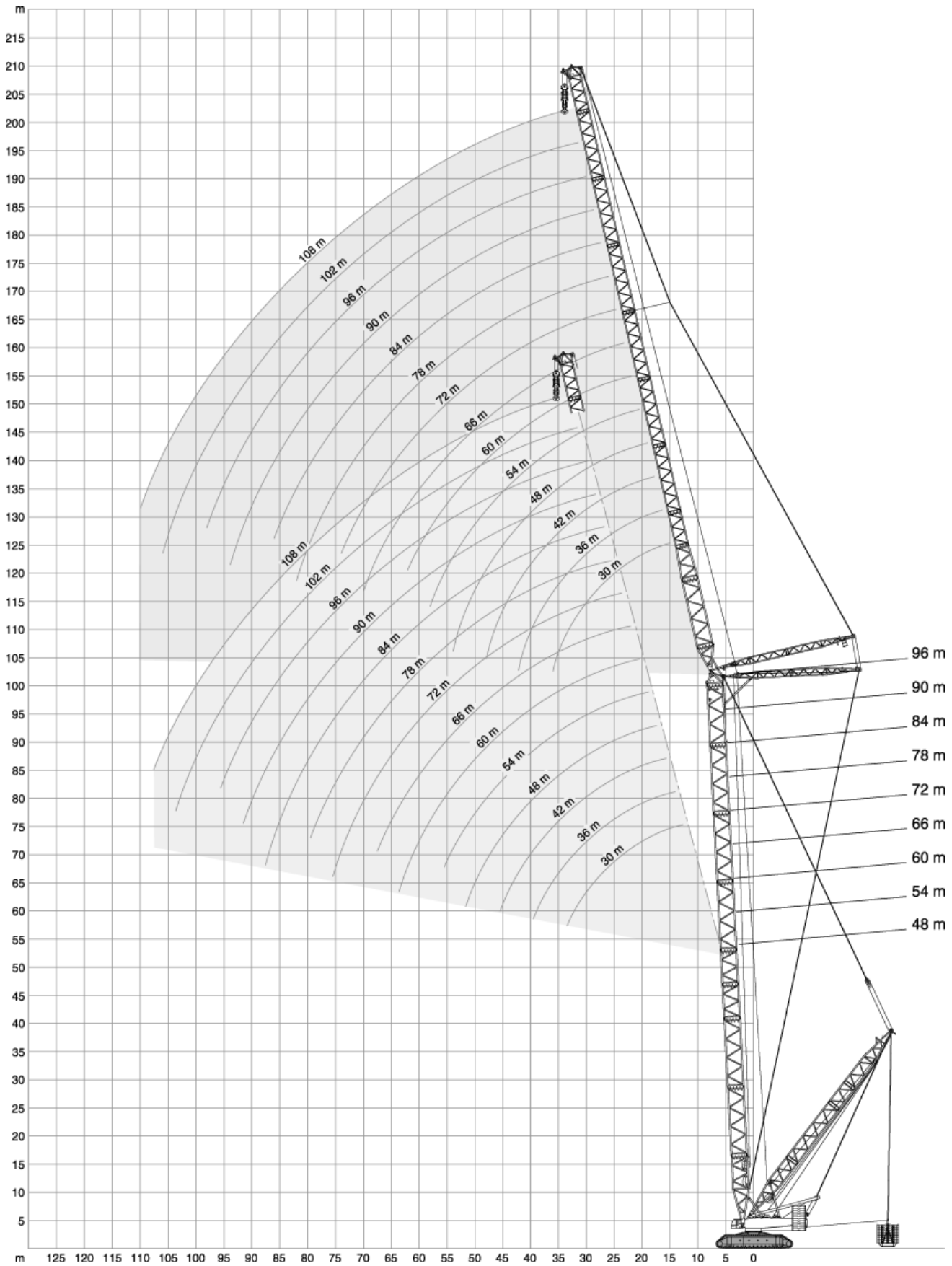

170-250 t 0-80 t 15-24 m 9,60 m 9.8 m/s 360° ISO

48 m + 36 m

m	SWSL						SFSL
	0 t		80 t-450 t				t
	85°	85°	75°	65°	55°	45°	
15	-	484,0*	-	-	-	-	-
16	-	484,0*	-	-	-	-	-
18	280,0	501,0	-	-	-	-	-
19	266,0	501,0	-	-	-	-	467,0
20	253,0	496,0	-	-	-	-	467,0
22	231,0	484,0	-	-	-	-	467,0
24	210,0	471,0	-	-	-	-	467,0
26	190,0	436,0	-	-	-	-	467,0
28	172,5	391,0	-	-	-	-	464,0
30	158,0	354,0	-	-	-	-	451,0
32	145,5	323,0	425,0	-	-	-	421,5
34	134,5	297,0	399,0	-	-	-	392,0
38	116,0	255,0	354,0	-	-	-	344,0
40	108,5	238,0	329,0	-	-	-	325,0
42	-	-	302,0	-	-	-	306,0
46	-	-	259,0	276,0	-	-	274,0
50	-	-	226,0	251,0	-	-	247,0
54	-	-	-	230,0	-	-	217,0
58	-	-	-	212,0	188,0	-	191,0
62	-	-	-	-	173,5	-	168,0
66	-	-	-	-	-	-	153,0
70	-	-	-	-	-	-	133,0
74	-	-	-	-	-	-	115,0
78	-	-	-	-	-	-	97,0
82	-	-	-	-	-	-	-

48 m + 60 m

m	SWSL						SFSL
	0 t		80 t-450 t				t
	85°	85°	75°	65°	55°	45°	
22	-	282,0*	-	-	-	-	-
24	188,0	287,0	-	-	-	-	-
26	173,5	287,0	-	-	-	-	-
28	161,5	285,0	-	-	-	-	278,0
30	150,5	284,0	-	-	-	-	278,0
34	132,0	277,0	-	-	-	-	278,0
38	114,5	268,0	-	-	-	-	278,0
42	99,6	237,0	278,0	-	-	-	278,0
46	87,4	209,0	276,0	-	-	-	271,0
50	77,2	186,0	241,0	-	-	-	252,0
54	68,7	166,5	212,0	-	-	-	229,0
58	61,4	150,0	188,5	-	-	-	209,0
62	55,0	136,0	169,0	193,0	-	-	192,0
66	-	-	152,5	179,0	-	-	174,0
70	-	-	138,0	166,0	-	-	156,0
74	-	-	-	153,0	-	-	140,0
78	-	-	-	138,5	126,0	-	125,0
82	-	-	-	-	118,0	-	116,0
86	-	-	-	-	111,5	-	104,0
90	-	-	-	-	-	92,6	92,0
94	-	-	-	-	-	87,1	80,5
98	-	-	-	-	-	-	69,0
102	-	-	-	-	-	-	57,5

48 m + 48 m

m	t	t	t	t	t	t	t
18	-	368,0*	-	-	-	-	-
20	-	366,0*	-	-	-	-	-
22	217,0	378,0	-	-	-	-	-
24	199,5	377,0	-	-	-	-	359,0
26	184,5	374,0	-	-	-	-	359,0
28	170,0	367,0	-	-	-	-	359,0
30	155,5	359,0	-	-	-	-	359,0
34	132,0	315,0	-	-	-	-	359,0
38	113,5	269,0	351,0	-	-	-	347,0
42	99,2	234,0	313,0	-	-	-	308,0
46	87,3	206,0	274,0	-	-	-	276,0
50	77,5	183,0	238,0	-	-	-	249,0
54	-	-	209,0	227,0	-	-	226,0
58	-	-	186,0	209,0	-	-	204,0
62	-	-	-	193,0	-	-	181,0
66	-	-	-	179,0	157,0	-	161,0
70	-	-	-	-	145,5	-	143,0
74	-	-	-	-	136,0	-	132,0
78	-	-	-	-	-	114,5	116,0
82	-	-	-	-	-	107,0	102,0
86	-	-	-	-	-	-	88,0
90	-	-	-	-	-	-	74,0
94	-	-	-	-	-	-	-

48 m + 72 m

m	t	t	t	t	t	t	t
24	-	216,0*	-	-	-	-	-
26	-	214,0*	-	-	-	-	-
28	151,0	216,0	-	-	-	-	-
30	141,0	216,0	-	-	-	-	210,0
34	123,5	213,0	-	-	-	-	210,0
38	107,5	208,0	-	-	-	-	210,0
42	93,4	204,0	-	-	-	-	210,0
46	81,7	199,0	-	-	-	-	209,0
48	76,6	192,5	205,0	-	-	-	208,0
50	72,0	181,5	205,0	-	-	-	207,0
54	63,8	162,5	204,0	-	-	-	201,0
58	56,7	147,0	184,0	-	-	-	195,0
62	50,6	133,0	165,0	-	-	-	183,0
66	45,3	121,5	149,0	172,0	-	-	172,0
70	40,6	111,0	135,0	160,0	-	-	161,0
74	36,4	101,5	123,0	149,0	-	-	145,0
78	-	-	112,5	135,5	-	-	130,0
82	-	-	103,0	123,5	-	-	117,0
86	-	-	-	113,0	106,5	-	106,0
90	-	-	-	103,5	100,0	-	99,0
94	-	-	-	-	94,9	-	89,0
98	-	-	-	-	89,9	76,6	79,0
102	-	-	-	-	-	72,1	69,5
106	-	-	-	-	-	67,9	60,5
110	-	-	-	-	-	-	51,0
114	-	-	-	-	-	-	42,0
118	-	-	-	-	-	-	-

* Main boom angle 87° · Hauptauslegerwinkel 87° · Jarret de flèche principale 87° · Inclinazione braccio base 87° · Ángulo de pluma principal 87° · Ángulo da lança principal 87° · Угол подъема гл. стрелы 87°

For explanations see page 45 · Bemerkungen siehe Seite 45 · Pour plus de détails, voir page 45 · Per spiegazioni vedere a pagina 45 · Véase p. 45 para más información · Para explicações, ver página 45 · Объяснения см. на стр. 45

170-250 t 0-80 t 15-24 m 9,60 m 9.8 m/s 360° ISO

48 m + 84 m

m	SWSL						SFSL
	0 t		80 t-450 t				
	85°	85°	75°	65°	55°	45°	t
26	-	164,5*	-	-	-	-	-
28	-	164,0*	-	-	-	-	-
30	-	162,5*	-	-	-	-	-
32	124,5	164,0	-	-	-	-	-
34	116,5	163,0	-	-	-	-	160,0
38	103,0	161,0	-	-	-	-	159,0
42	91,2	158,5	-	-	-	-	159,0
46	79,5	156,0	-	-	-	-	159,0
50	69,8	153,0	-	-	-	-	157,0
54	61,6	150,0	152,5	-	-	-	156,0
58	54,5	146,0	152,5	-	-	-	153,0
62	48,5	132,5	152,5	-	-	-	151,0
66	43,1	120,5	148,0	-	-	-	148,0
70	38,4	110,0	134,0	-	-	-	146,0
74	34,2	101,0	122,0	136,0	-	-	140,0
78	30,5	93,2	111,5	134,5	-	-	132,0
82	27,1	85,9	102,5	122,5	-	-	124,0
86	24,1	79,2	94,4	112,0	-	-	112,0
90	-	-	87,1	103,0	-	-	101,0
94	-	-	80,3	94,8	92,6	-	93,0
98	-	-	-	87,4	87,6	-	86,5
102	-	-	-	80,8	83,0	-	77,5
106	-	-	-	-	78,7	-	69,0
110	-	-	-	-	74,6	60,9	61,0
114	-	-	-	-	-	57,4	53,5
118	-	-	-	-	-	54,1	46,1
122	-	-	-	-	-	-	38,4
126	-	-	-	-	-	-	30,5
130	-	-	-	-	-	-	-

48 m + 96 m

m	t	t	t	t	t	t	t
30	-	123,5*	-	-	-	-	-
34	109,5	122,5	-	-	-	-	-
38	97,1	121,0	-	-	-	-	119,0
42	86,4	119,0	-	-	-	-	118,0
46	77,2	117,0	-	-	-	-	117,0
50	67,5	115,0	-	-	-	-	117,0
54	59,2	112,5	-	-	-	-	115,0
58	52,2	110,0	110,5	-	-	-	113,0
62	46,0	108,0	110,0	-	-	-	112,0
66	40,7	105,5	109,5	-	-	-	109,0
70	36,0	103,0	108,5	-	-	-	107,0
74	31,8	100,0	107,5	-	-	-	105,0
78	28,1	91,9	106,0	-	-	-	103,0
82	24,7	84,7	101,0	96,5	-	-	101,0
86	21,7	78,1	93,1	96,5	-	-	99,5
90	18,9	72,2	85,7	96,5	-	-	97,5
94	16,3	66,8	79,1	93,3	-	-	95,0
98	14,0	61,7	73,2	86,0	-	-	87,5
102	-	-	67,7	79,5	80,6	-	81,0
106	-	-	62,6	73,5	75,9	-	75,0
110	-	-	-	68,0	71,5	-	67,5
114	-	-	-	63,0	67,5	-	60,0
118	-	-	-	-	63,8	51,2	53,0
122	-	-	-	-	60,3	48,5	46,7
126	-	-	-	-	-	46,0	40,2
130	-	-	-	-	-	43,6	33,8
134	-	-	-	-	-	-	27,3

48 m + 108 m

m	SWSL						SFSL
	0 t		80 t-450 t				
	85°	85°	75°	65°	55°	45°	t
32	-	94,2*	-	-	-	-	-
34	-	93,8*	-	-	-	-	-
38	88,3	93,0	-	-	-	-	-
42	80,8	91,6	-	-	-	-	90,5
46	72,0	90,2	-	-	-	-	89,5
50	64,5	88,8	-	-	-	-	89,0
54	57,1	87,3	-	-	-	-	88,0
58	50,0	85,8	-	-	-	-	86,5
62	43,9	84,2	-	-	-	-	85,5
66	38,5	82,7	82,2	-	-	-	84,0
70	33,8	81,2	81,7	-	-	-	82,5
74	29,6	79,7	81,2	-	-	-	81,0
78	25,8	78,0	80,6	-	-	-	79,0
82	22,4	75,7	80,0	-	-	-	77,5
86	19,4	72,8	79,3	-	-	-	76,0
90	16,6	69,8	78,7	70,6	-	-	74,5
94	14,0	65,6	77,8	70,6	-	-	73,0
98	11,7	60,6	71,8	70,6	-	-	71,5
102	9,5	56,1	66,4	70,6	-	-	69,5
106	7,6	51,9	61,4	70,6	-	-	67,5
110	5,7	47,9	56,9	66,7	61,6	-	65,5
114	-	-	52,6	61,7	61,6	-	63,0
118	-	-	48,6	57,1	61,0	-	58,0
122	-	-	-	52,9	57,5	-	52,0
126	-	-	-	48,9	54,2	-	46,0
130	-	-	-	-	51,2	41,0	40,2
134	-	-	-	-	48,3	38,7	34,5
138	-	-	-	-	-	36,6	28,9
142	-	-	-	-	-	-	23,4
146	-	-	-	-	-	-	17,7
150	-	-	-	-	-	-	-

* Main boom angle 87° · Hauptauslegerwinkel 87° ·
 Jarret de flèche principale 87° · Inclinazione braccio base 87° ·
 Ángulo de pluma principal 87° · Ángulo da lança principal 87° ·
 Угол подъема гл. стрелы 87°

Main boom angle 87°, 85°, 75°, 65°, 55° and 45°, capacities for intermediate boom positions are calculated by the crane control system IC-1

Hauptauslegerwinkel 87°, 85°, 75°, 65°, 55° und 45°, Traglasten für Zwischenstellungen des Hauptauslegers werden von der Kransteuerung IC-1 berechnet

Jarret de flèche principale 87°, 85°, 75°, 65°, 55° et 45°, le système de commande de la grue IC-1 calcule les charges pour les positions intermédiaires de la flèche

Inclinazione braccio base 87°, 85°, 75°, 65°, 55° e 45°, capacità per posizioni intermedie del braccio sono calcolate dal sistema di controllo della gru IC-1

Ángulo de pluma principal 87°, 85°, 75°, 65°, 55° y 45° las capacidades para posiciones de pluma intermedias son calculadas por el sistema de control de grúa IC-1

Ângulos da lança principal 87°, 85°, 75°, 65°, 55° e 45°; as capacidades para posições da lança intermediária são calculadas pelo sistema de controle da grua IC-1

Грузоподъемность при углах подъема главной стрелы 87°, 85°, 75°, 65°, 55° и 45°, грузоподъемность в промежуточных положениях стрелы рассчитывается системой управления краном IC-1

170-250 t 0-80 t 15-24 m 9,60 m 9.8 m/s 360° ISO

54 m + 36 m

m	SWSL						SFSL
	0 t		80 t-450 t				
	85°	85°	75°	65°	55°	45°	t
16	-	450,0*	-	-	-	-	-
18	-	439,0*	-	-	-	-	-
19	256,0	463,0	-	-	-	-	434,0
20	244,0	458,0	-	-	-	-	434,0
22	222,0	448,0	-	-	-	-	434,0
24	205,0	437,0	-	-	-	-	434,0
26	187,5	425,0	-	-	-	-	434,0
28	170,5	401,0	-	-	-	-	430,0
30	156,0	363,0	-	-	-	-	426,0
34	132,5	303,0	394,0	-	-	-	389,0
38	114,5	260,0	350,0	-	-	-	341,0
42	99,9	226,0	312,0	-	-	-	303,0
46	-	-	274,0	-	-	-	271,0
48	-	-	254,0	259,0	-	-	257,5
50	-	-	237,0	247,0	-	-	244,0
54	-	-	-	226,0	-	-	221,0
58	-	-	-	208,0	-	-	202,0
62	-	-	-	-	177,5	-	178,0
66	-	-	-	-	164,5	-	157,0
70	-	-	-	-	-	-	138,0
74	-	-	-	-	-	-	127,0
78	-	-	-	-	-	-	110,0
82	-	-	-	-	-	-	93,5

54 m + 60 m

m	SWSL						SFSL
	0 t		80 t-450 t				
	85°	85°	75°	65°	55°	45°	t
22	-	265,0*	-	-	-	-	-
24	-	264,0*	-	-	-	-	-
26	167,5	270,0	-	-	-	-	-
28	156,0	269,0	-	-	-	-	262,0
30	145,5	268,0	-	-	-	-	262,0
34	128,0	262,0	-	-	-	-	262,0
38	113,0	254,0	-	-	-	-	262,0
42	98,1	245,0	-	-	-	-	260,0
44	91,8	229,0	265,0	-	-	-	257,5
46	86,0	215,0	263,0	-	-	-	257,0
50	75,9	191,5	256,0	-	-	-	248,0
54	67,5	171,0	226,0	-	-	-	227,0
58	60,2	154,5	200,0	-	-	-	207,0
62	54,0	139,5	178,5	190,5	-	-	189,0
66	-	-	160,5	177,0	-	-	174,0
70	-	-	145,5	164,5	-	-	160,0
74	-	-	132,0	154,0	-	-	147,0
78	-	-	-	144,5	128,5	-	132,0
82	-	-	-	136,0	120,5	-	119,0
86	-	-	-	-	113,0	-	106,0
90	-	-	-	-	106,0	-	97,0
94	-	-	-	-	-	88,4	88,0
98	-	-	-	-	-	83,3	77,0
102	-	-	-	-	-	-	66,5
106	-	-	-	-	-	-	61,0

54 m + 48 m

m	t	t	t	t	t	t	t
18	-	345,0*	-	-	-	-	-
20	-	343,0*	-	-	-	-	-
22	209,0	352,0	-	-	-	-	-
24	192,5	351,0	-	-	-	-	336,0
26	178,0	348,0	-	-	-	-	336,0
28	165,5	342,0	-	-	-	-	336,0
30	153,5	335,0	-	-	-	-	336,0
34	130,0	321,0	-	-	-	-	333,0
38	112,0	278,0	-	-	-	-	330,0
40	104,0	258,0	328,0	-	-	-	317,5
42	97,5	241,0	310,0	-	-	-	305,0
46	85,8	212,0	279,0	-	-	-	273,0
50	76,0	188,0	254,0	-	-	-	246,0
54	67,8	166,5	222,0	-	-	-	223,0
58	-	-	197,0	205,0	-	-	203,0
62	-	-	175,5	190,0	-	-	186,0
66	-	-	-	176,5	-	-	170,0
70	-	-	-	165,0	148,5	-	151,0
74	-	-	-	-	138,5	-	135,0
78	-	-	-	-	130,0	-	119,0
82	-	-	-	-	-	108,5	110,0
86	-	-	-	-	-	102,0	97,5
90	-	-	-	-	-	-	84,5
94	-	-	-	-	-	-	75,0
98	-	-	-	-	-	-	-

54 m + 72 m

m	t	t	t	t	t	t	t
24	-	204,0*	-	-	-	-	-
26	-	203,0*	-	-	-	-	-
28	145,5	206,0	-	-	-	-	-
30	136,0	205,0	-	-	-	-	-
34	119,5	202,0	-	-	-	-	200,0
38	105,5	199,0	-	-	-	-	200,0
42	91,9	195,0	-	-	-	-	200,0
46	80,3	190,5	-	-	-	-	200,0
50	70,7	186,0	196,5	-	-	-	200,0
54	62,6	167,5	196,0	-	-	-	194,0
58	55,6	151,0	194,5	-	-	-	189,0
62	49,6	137,0	174,5	-	-	-	184,0
66	44,3	124,5	157,0	-	-	-	174,0
70	39,7	114,0	142,0	158,5	-	-	160,0
74	35,5	104,5	129,5	148,5	-	-	148,0
78	-	-	118,0	139,0	-	-	137,0
82	-	-	108,0	131,0	-	-	124,0
86	-	-	99,4	121,5	107,0	-	112,0
90	-	-	-	111,0	100,5	-	100,0
94	-	-	-	102,0	94,8	-	90,0
98	-	-	-	-	89,4	-	83,5
102	-	-	-	-	84,3	73,1	75,5
106	-	-	-	-	-	68,9	66,5
110	-	-	-	-	-	65,0	58,0
114	-	-	-	-	-	-	51,5
118	-	-	-	-	-	-	45,0
122	-	-	-	-	-	-	-

* Main boom angle 87° · Hauptauslegerwinkel 87° ·
 Jarret de flèche principale 87° · Inclinazione braccio base 87° ·
 Ângulo de pluma principal 87° · Ângulo da lança principal 87° ·
 Угол подъема гл. стрелы 87°

For explanations see page 47 · Bemerkungen siehe Seite 47 · Pour plus de détails, voir page 47 · Per spiegazioni vedere a pagina 47 ·
 Véase p. 47 para más información · Para explicações, ver página 47 · Объяснения см. на стр. 47

170-250 t 0-80 t 15-24 m 9,60 m 9.8 m/s 360° ISO

54 m + 84 m

m	SWSL						SFSL
	0 t		80 t-450 t				
	85°	85°	75°	65°	55°	45°	t
26	-	157,0*	-	-	-	-	-
28	-	156,5*	-	-	-	-	-
30	-	155,0*	-	-	-	-	-
32	120,0	156,5	-	-	-	-	-
34	112,5	155,5	-	-	-	-	-
38	99,7	154,0	-	-	-	-	152,0
42	88,9	151,5	-	-	-	-	152,0
46	78,2	149,5	-	-	-	-	152,0
50	68,5	146,5	-	-	-	-	151,0
54	60,4	144,0	146,5	-	-	-	150,0
58	53,4	141,5	146,5	-	-	-	148,0
62	47,4	136,0	146,5	-	-	-	146,0
66	42,1	124,0	146,0	-	-	-	143,0
70	37,5	113,5	141,5	-	-	-	141,0
74	33,4	104,0	128,5	-	-	-	139,0
78	29,7	95,7	117,5	130,5	-	-	136,0
82	26,3	88,2	107,5	128,5	-	-	128,0
86	23,3	81,4	99,1	120,5	-	-	118,0
90	-	-	91,3	110,5	-	-	107,0
94	-	-	84,3	101,5	-	-	97,0
98	-	-	77,7	93,6	86,3	-	87,5
102	-	-	-	86,4	81,3	-	78,5
106	-	-	-	79,8	76,7	-	72,5
110	-	-	-	-	72,4	-	66,0
114	-	-	-	-	68,5	58,2	58,5
118	-	-	-	-	-	54,9	51,0
122	-	-	-	-	-	51,8	44,5
126	-	-	-	-	-	-	40,7
130	-	-	-	-	-	-	33,4

54 m + 96 m

m	t	t	t	t	t	t	t
30	-	118,5*	-	-	-	-	-
34	105,5	117,0	-	-	-	-	-
38	93,5	116,0	-	-	-	-	114,0
42	83,2	114,5	-	-	-	-	113,0
46	74,3	112,5	-	-	-	-	113,0
50	66,2	110,5	-	-	-	-	112,0
54	58,0	108,5	-	-	-	-	111,0
58	51,0	106,5	-	-	-	-	110,0
62	45,0	104,0	106,0	-	-	-	108,0
66	39,7	102,0	106,0	-	-	-	107,0
70	35,1	99,9	105,5	-	-	-	105,0
74	30,9	97,0	104,5	-	-	-	103,0
78	27,2	93,2	103,5	-	-	-	101,0
82	23,9	87,1	102,5	-	-	-	99,0
86	20,9	80,4	97,8	92,8	-	-	97,0
90	18,1	74,3	90,1	92,8	-	-	95,5
94	15,6	68,7	83,1	92,8	-	-	93,5
98	13,3	63,5	76,8	92,2	-	-	91,5
102	-	-	71,1	85,1	-	-	83,5
106	-	-	65,8	78,6	73,6	-	75,5
110	-	-	-	72,8	69,5	-	68,0
114	-	-	-	67,4	65,9	-	62,5
118	-	-	-	62,4	62,6	-	57,5
122	-	-	-	-	59,5	48,4	51,0
126	-	-	-	-	56,6	45,5	44,6
130	-	-	-	-	-	42,8	38,4
134	-	-	-	-	-	40,3	34,1
138	-	-	-	-	-	-	29,5
142	-	-	-	-	-	-	23,1

54 m + 108 m

m	SWSL						SFSL
	0 t		80 t-450 t				
	85°	85°	75°	65°	55°	45°	t
32	-	90,3*	-	-	-	-	-
34	-	89,9*	-	-	-	-	-
38	84,8	89,0	-	-	-	-	-
42	77,6	88,0	-	-	-	-	86,5
46	69,1	86,8	-	-	-	-	86,0
50	61,9	85,5	-	-	-	-	85,5
54	55,5	84,2	-	-	-	-	85,0
58	48,9	82,8	-	-	-	-	83,5
62	42,8	81,3	-	-	-	-	82,5
66	37,5	79,9	79,1	-	-	-	81,5
70	32,8	78,4	78,9	-	-	-	80,0
74	28,7	77,0	78,6	-	-	-	78,5
78	25,0	75,5	78,2	-	-	-	77,0
82	21,6	73,3	77,7	-	-	-	75,5
86	18,6	70,3	77,2	-	-	-	74,0
90	15,8	67,3	76,7	67,7	-	-	72,5
94	13,3	64,3	76,0	67,7	-	-	71,0
98	11,0	61,3	75,1	67,7	-	-	70,0
102	8,9	57,8	69,8	67,7	-	-	68,0
106	6,9	53,5	64,6	67,7	-	-	67,0
110	5,1	49,4	59,8	67,7	-	-	64,5
114	-	-	55,4	66,1	59,0	-	62,5
118	-	-	51,2	61,3	59,0	-	58,5
122	-	-	-	56,7	57,1	-	53,5
126	-	-	-	52,5	54,2	-	49,7
130	-	-	-	48,6	51,4	-	43,8
134	-	-	-	-	48,9	37,2	38,2
138	-	-	-	-	46,5	34,8	32,7
142	-	-	-	-	-	32,5	28,0
146	-	-	-	-	-	-	25,2
150	-	-	-	-	-	-	19,8
154	-	-	-	-	-	-	14,2
158	-	-	-	-	-	-	-

* Main boom angle 87° · Hauptauslegerwinkel 87° ·
Jarret de flèche principale 87° · Inclinazione braccio base 87° ·
Ângulo de pluma principal 87° · Ângulo da lança principal 87° ·
Угол подъема пл. стрелы 87°

Main boom angle 87°, 85°, 75°, 65°, 55° and 45°, capacities for intermediate boom positions are calculated by the crane control system IC-1

Hauptauslegerwinkel 87°, 85°, 75°, 65°, 55° und 45°, Traglasten für Zwischenstellungen des Hauptauslegers werden von der Kransteuerung IC-1 berechnet

Jarret de flèche principale 87°, 85°, 75°, 65°, 55° et 45°, le système de commande de la grue IC-1 calcule les charges pour les positions intermédiaires de la flèche

Inclinazione braccio base 87°, 85°, 75°, 65°, 55° e 45°, capacità per posizioni intermedie del braccio sono calcolate dal sistema di controllo della gru IC-1

Ângulo de pluma principal 87°, 85°, 75°, 65°, 55° y 45° las capacidades para posiciones de pluma intermedias son calculadas por el sistema de control de grúa IC-1

Ângulos da lança principal 87°, 85°, 75°, 65°, 55° e 45°; as capacidades para posições da lança intermediária são calculadas pelo sistema de controle da grua IC-1

Грузоподъемность при углах подъема главной стрелы 87°, 85°, 75°, 65°, 55° и 45°, грузоподъемность в промежуточных положениях стрелы рассчитывается системой управления краном IC-1

170-250 t 0-80 t 15-24 m 9,60 m 9.8 m/s 360° ISO

60 m + 36 m

m	SWSL						SFSL
	0 t		80 t-450 t				
	85°	85°	75°	65°	55°	45°	t
16	-	412,0*	-	-	-	-	-
18	-	402,0*	-	-	-	-	-
19	246,0	427,0	-	-	-	-	-
20	234,0	427,0	-	-	-	-	396,0
22	214,0	419,0	-	-	-	-	396,0
24	197,5	410,0	-	-	-	-	396,0
26	182,5	400,0	-	-	-	-	396,0
28	168,0	383,0	-	-	-	-	396,0
30	153,5	370,0	-	-	-	-	392,0
34	130,5	309,0	-	-	-	-	386,0
36	121,0	285,0	366,0	-	-	-	362,0
38	112,5	264,0	346,0	-	-	-	338,0
42	98,2	230,0	309,0	-	-	-	300,0
46	-	-	278,0	-	-	-	268,0
50	-	-	250,0	-	-	-	241,0
53	-	-	-	226,0	-	-	223,7
54	-	-	-	221,0	-	-	218,0
58	-	-	-	204,0	-	-	198,0
62	-	-	-	189,0	-	-	181,0
66	-	-	-	-	164,5	-	164,0
70	-	-	-	-	153,5	-	145,0
74	-	-	-	-	-	-	128,0
78	-	-	-	-	-	-	114,0
82	-	-	-	-	-	-	103,0
86	-	-	-	-	-	-	88,5
90	-	-	-	-	-	-	76,5
94	-	-	-	-	-	-	-

60 m + 60 m

m	SWSL						SFSL
	0 t		80 t-450 t				
	85°	85°	75°	65°	55°	45°	t
22	-	248,0*	-	-	-	-	-
24	-	247,0*	-	-	-	-	-
26	161,5	254,0	-	-	-	-	-
28	150,0	254,0	-	-	-	-	244,0
30	140,0	254,0	-	-	-	-	244,0
34	123,5	250,0	-	-	-	-	244,0
38	109,5	243,0	-	-	-	-	244,0
42	96,4	236,0	-	-	-	-	244,0
46	84,4	221,0	250,0	-	-	-	242,0
50	74,5	196,0	248,0	-	-	-	234,0
54	66,1	175,5	231,0	-	-	-	224,0
58	59,0	158,0	211,0	-	-	-	204,0
62	52,8	143,0	188,5	-	-	-	186,0
66	47,3	128,0	169,0	173,0	-	-	171,0
70	-	-	152,5	161,0	-	-	157,0
74	-	-	138,5	150,5	-	-	145,0
78	-	-	-	141,5	-	-	134,0
82	-	-	-	133,0	120,5	-	123,0
86	-	-	-	125,0	113,0	-	110,0
90	-	-	-	-	106,0	-	99,0
94	-	-	-	-	100,0	-	88,0
98	-	-	-	-	-	81,9	80,5
102	-	-	-	-	-	77,6	72,0
106	-	-	-	-	-	-	62,5
110	-	-	-	-	-	-	53,0

60 m + 48 m

m	SWSL						
	t	t	t	t	t	t	t
19	-	320,0*	-	-	-	-	-
20	-	318,0*	-	-	-	-	-
22	201,0	331,0	-	-	-	-	-
24	185,5	329,0	-	-	-	-	310,0
26	171,5	327,0	-	-	-	-	310,0
28	159,5	323,0	-	-	-	-	310,0
30	149,0	317,0	-	-	-	-	310,0
34	127,5	304,0	-	-	-	-	310,0
38	110,0	283,0	-	-	-	-	307,0
41	99,1	254,5	315,0	-	-	-	302,5
42	95,7	246,0	306,0	-	-	-	302,0
46	84,1	217,0	276,0	-	-	-	270,0
50	74,5	192,5	250,0	-	-	-	243,0
54	66,3	171,5	229,0	-	-	-	220,0
58	-	-	207,0	201,0	-	-	200,0
62	-	-	185,0	186,0	-	-	183,0
66	-	-	-	173,0	-	-	167,0
70	-	-	-	161,0	-	-	154,0
74	-	-	-	151,0	138,5	-	140,0
78	-	-	-	-	130,0	-	125,0
82	-	-	-	-	122,0	-	111,0
86	-	-	-	-	-	98,8	99,0
90	-	-	-	-	-	93,4	91,0
94	-	-	-	-	-	-	79,5
98	-	-	-	-	-	-	68,0

60 m + 72 m

m	SWSL						
	t	t	t	t	t	t	t
24	-	193,0*	-	-	-	-	-
26	-	192,0*	-	-	-	-	-
28	140,0	195,5	-	-	-	-	-
30	131,0	195,5	-	-	-	-	-
34	115,0	193,5	-	-	-	-	188,0
38	102,0	190,5	-	-	-	-	188,0
42	90,2	187,0	-	-	-	-	188,0
46	78,8	183,0	-	-	-	-	188,0
50	69,3	179,0	-	-	-	-	188,0
54	61,3	171,5	186,0	-	-	-	186,0
58	54,4	154,5	185,5	-	-	-	180,0
62	48,5	140,0	184,5	-	-	-	175,0
66	43,2	127,5	165,5	-	-	-	171,0
70	38,6	116,5	149,5	-	-	-	157,0
74	34,5	106,5	135,5	145,0	-	-	145,0
78	-	-	123,5	136,0	-	-	134,0
82	-	-	113,0	127,5	-	-	124,0
86	-	-	103,5	120,5	-	-	115,0
90	-	-	-	113,5	100,5	-	104,0
94	-	-	-	107,5	94,7	-	94,0
98	-	-	-	100,0	89,2	-	84,0
102	-	-	-	-	84,2	-	75,0
106	-	-	-	-	79,6	68,0	68,5
110	-	-	-	-	-	64,1	62,0
114	-	-	-	-	-	60,5	54,0
118	-	-	-	-	-	-	46,2
122	-	-	-	-	-	-	40,6

For explanations see page 49 · Bemerkungen siehe Seite 49 · Pour plus de détails, voir page 49 · Per spiegazioni vedere a pagina 49 · Véase p. 49 para más información · Para explicações, ver página 49 · Объяснения см. на стр. 49

170-250 t 0-80 t		15-24 m		9,60 m		9.8 m/s		360°		ISO		
60 m + 84 m						60 m + 96 m						
		SWSL					SFSL					
		0 t	80 t-450 t									
		85°	85°	75°	65°	55°	45°					
m	t	t	t	t	t	t	t	t	t	t		
28	-	148,5*	-	-	-	-	-	-	-	-		
30	-	147,5*	-	-	-	-	-	-	-	-		
32	115,5	149,0	-	-	-	-	-	-	-	-		
34	108,0	149,0	-	-	-	-	-	-	-	-		
38	95,9	147,5	-	-	-	-	-	-	144,0	-		
42	85,5	145,5	-	-	-	-	-	-	144,0	-		
46	76,6	143,5	-	-	-	-	-	-	144,0	-		
50	67,1	141,0	-	-	-	-	-	-	144,0	-		
54	59,1	138,5	-	-	-	-	-	-	144,0	-		
58	52,2	136,5	140,0	-	-	-	-	-	143,0	-		
62	46,3	134,0	139,5	-	-	-	-	-	140,0	-		
66	41,0	127,0	139,5	-	-	-	-	-	138,0	-		
70	36,5	116,0	139,0	-	-	-	-	-	135,0	-		
74	32,4	106,5	135,0	-	-	-	-	-	133,0	-		
78	28,7	97,9	123,0	124,0	-	-	-	-	131,0	-		
82	25,4	90,2	112,5	124,0	-	-	-	-	125,0	-		
86	22,4	83,2	103,5	118,0	-	-	-	-	116,0	-		
90	-	-	95,4	111,5	-	-	-	-	107,0	-		
94	-	-	88,0	105,5	-	-	-	-	99,5	-		
98	-	-	81,2	99,7	86,0	-	-	-	90,5	-		
102	-	-	-	92,0	81,0	-	-	-	81,5	-		
106	-	-	-	84,9	76,5	-	-	-	73,0	-		
110	-	-	-	-	72,2	-	-	-	65,0	-		
114	-	-	-	-	68,3	-	-	-	59,5	-		
118	-	-	-	-	64,6	53,9	-	-	54,5	-		
122	-	-	-	-	-	50,8	-	-	47,6	-		
126	-	-	-	-	-	47,9	-	-	40,8	-		
130	-	-	-	-	-	-	-	-	34,2	-		
134	-	-	-	-	-	-	-	-	30,8	-		
						0 t	80 t-450 t					SFSL
						85°	85°	75°	65°	55°	45°	
						m	t	t	t	t	t	t
30	-	112,5*	-	-	-	-	-	-	-	-	-	-
34	-	111,0*	-	-	-	-	-	-	-	-	-	-
36	95,4	112,0	-	-	-	-	-	-	-	-	-	-
38	89,7	111,5	-	-	-	-	-	-	-	-	-	-
42	79,8	110,0	-	-	-	-	-	-	-	-	108,0	-
46	71,3	108,5	-	-	-	-	-	-	-	-	108,0	-
50	64,0	106,5	-	-	-	-	-	-	-	-	108,0	-
54	56,7	105,0	-	-	-	-	-	-	-	-	107,0	-
58	49,8	103,0	-	-	-	-	-	-	-	-	106,0	-
62	43,8	101,0	101,5	-	-	-	-	-	-	-	105,0	-
66	38,6	99,0	101,5	-	-	-	-	-	-	-	103,0	-
70	34,0	97,0	101,5	-	-	-	-	-	-	-	101,0	-
74	29,9	94,6	101,5	-	-	-	-	-	-	-	100,0	-
78	26,3	91,5	100,5	-	-	-	-	-	-	-	98,0	-
82	23,0	88,3	99,7	-	-	-	-	-	-	-	96,5	-
86	20,0	82,2	98,5	88,7	-	-	-	-	-	-	94,5	-
90	17,3	76,0	94,1	88,7	-	-	-	-	-	-	93,0	-
94	14,8	70,3	86,8	88,7	-	-	-	-	-	-	91,0	-
98	12,6	65,0	80,2	88,7	-	-	-	-	-	-	89,0	-
102	-	-	74,2	88,7	-	-	-	-	-	-	86,0	-
106	-	-	68,7	83,7	-	-	-	-	-	-	78,0	-
110	-	-	63,5	77,5	69,0	-	-	-	-	-	70,5	-
114	-	-	-	71,7	65,1	-	-	-	-	-	63,0	-
118	-	-	-	66,4	61,4	-	-	-	-	-	56,0	-
122	-	-	-	-	58,0	-	-	-	-	-	51,0	-
126	-	-	-	-	54,8	44,5	-	-	-	-	47,0	-
130	-	-	-	-	51,8	41,8	-	-	-	-	41,1	-
134	-	-	-	-	-	39,3	-	-	-	-	35,1	-
138	-	-	-	-	-	37,0	-	-	-	-	29,3	-
142	-	-	-	-	-	-	-	-	-	-	25,8	-
146	-	-	-	-	-	-	-	-	-	-	20,8	-

* Main boom angle 87° · Hauptauslegerwinkel 87° · Jarret de flèche principale 87° · Inclinação braccio base 87° · Ángulo de pluma principal 87° · Ángulo da lança principal 87° · Угол подъема гл. стрелы 87°

Main boom angle 87°, 85°, 75°, 65°, 55° and 45°, capacities for intermediate boom positions are calculated by the crane control system IC-1

Hauptauslegerwinkel 87°, 85°, 75°, 65°, 55° und 45°, Traglasten für Zwischenstellungen des Hauptauslegers werden von der Kransteuerung IC-1 berechnet

Jarret de flèche principale 87°, 85°, 75°, 65°, 55° et 45°, le système de commande de la grue IC-1 calcule les charges pour les positions intermédiaires de la flèche

Inclinação braccio base 87°, 85°, 75°, 65°, 55° e 45°, capacità per posizioni intermedie del braccio sono calcolate dal sistema di controllo della gru IC-1

Ángulo de pluma principal 87°, 85°, 75°, 65°, 55° y 45° las capacidades para posiciones de pluma intermedias son calculadas por el sistema de control de grúa IC-1

Ángulos da lança principal 87°, 85°, 75°, 65°, 55° e 45°, as capacidades para posições da lança intermediária são calculadas pelo sistema de controle da grua IC-1

Грузоподъемность при углах подъема главной стрелы 87°, 85°, 75°, 65°, 55° и 45°, грузоподъемность в промежуточных положениях стрелы рассчитывается системой управления краном IC-1

170-250 t 0-80 t 15-24 m 9,60 m 9.8 m/s 360° ISO

60 m + 108 m

m	SWSL						SFSL
	0 t		80 t-450 t				
	85°	85°	75°	65°	55°	45°	t
32	-	84,4*	-	-	-	-	-
34	-	84,1*	-	-	-	-	-
38	79,3	83,2	-	-	-	-	-
42	74,3	82,4	-	-	-	-	-
46	66,1	81,2	-	-	-	-	80,5
50	59,1	80,0	-	-	-	-	80,0
54	53,0	78,8	-	-	-	-	79,5
58	47,6	77,5	-	-	-	-	78,5
62	41,7	76,1	-	-	-	-	77,5
66	36,4	74,7	73,4	-	-	-	76,0
70	31,8	73,4	73,3	-	-	-	75,0
74	27,7	72,0	73,1	-	-	-	73,5
78	24,0	70,7	72,9	-	-	-	72,5
82	20,7	68,7	72,6	-	-	-	71,0
86	17,7	66,0	72,1	-	-	-	69,5
90	15,0	63,1	71,5	-	-	-	68,5
94	12,5	60,3	71,0	62,6	-	-	67,0
98	10,3	57,4	70,2	62,6	-	-	65,5
102	8,2	54,5	68,9	62,6	-	-	64,0
106	6,2	51,7	66,9	62,6	-	-	63,0
110	-	48,8	62,5	62,6	-	-	61,5
114	-	-	57,9	62,6	-	-	59,0
118	-	-	53,6	62,6	54,4	-	56,5
122	-	-	49,5	60,5	54,3	-	54,0
126	-	-	-	56,0	51,9	-	48,3
130	-	-	-	51,9	48,9	-	43,4
134	-	-	-	-	46,1	-	39,8
138	-	-	-	-	43,4	33,8	34,9
142	-	-	-	-	41,1	31,5	29,6
146	-	-	-	-	-	29,4	24,5
150	-	-	-	-	-	27,4	20,1
154	-	-	-	-	-	-	17,0
158	-	-	-	-	-	-	12,1

66 m + 36 m

m	t	t	t	t	t	t	t
16	-	379,0*	-	-	-	-	-
18	-	374,0*	-	-	-	-	-
20	225,0	389,0	-	-	-	-	368,0
22	206,0	385,0	-	-	-	-	368,0
24	190,0	378,0	-	-	-	-	368,0
26	176,0	369,0	-	-	-	-	368,0
28	164,0	360,0	-	-	-	-	363,0
30	151,5	351,0	-	-	-	-	363,0
34	128,5	316,0	-	-	-	-	356,0
38	110,5	269,0	341,0	-	-	-	335,0
42	96,6	233,0	305,0	-	-	-	297,0
46	-	-	275,0	-	-	-	265,0
50	-	-	250,0	-	-	-	238,0
54	-	-	229,0	217,0	-	-	215,0
58	-	-	-	200,0	-	-	195,0
62	-	-	-	185,0	-	-	178,0
66	-	-	-	-	-	-	162,0
70	-	-	-	-	151,0	-	149,0
74	-	-	-	-	141,5	-	134,0
78	-	-	-	-	-	-	118,0
82	-	-	-	-	-	-	104,0
86	-	-	-	-	-	-	94,5
90	-	-	-	-	-	-	82,5
94	-	-	-	-	-	-	69,5

66 m + 48 m

m	SWSL						SFSL
	0 t		80 t-450 t				
	85°	85°	75°	65°	55°	45°	t
19	-	297,0*	-	-	-	-	-
20	-	297,0*	-	-	-	-	-
22	-	293,0*	-	-	-	-	-
24	178,5	305,0	-	-	-	-	290,0
26	165,5	303,0	-	-	-	-	290,0
28	154,0	299,0	-	-	-	-	290,0
30	144,0	294,0	-	-	-	-	290,0
34	126,0	283,0	-	-	-	-	290,0
38	108,0	272,0	-	-	-	-	283,0
42	94,1	250,0	302,0	-	-	-	280,0
46	82,6	220,0	273,0	-	-	-	268,0
50	73,0	196,0	248,0	-	-	-	240,0
54	65,0	173,0	226,0	-	-	-	217,0
58	-	-	208,0	-	-	-	197,0
62	-	-	193,0	182,0	-	-	180,0
66	-	-	174,0	169,0	-	-	164,0
70	-	-	-	157,5	-	-	151,0
74	-	-	-	147,5	-	-	139,0
78	-	-	-	-	128,5	-	128,0
82	-	-	-	-	120,5	-	115,0
86	-	-	-	-	113,5	-	103,0
90	-	-	-	-	-	88,9	91,0
94	-	-	-	-	-	84,1	81,5
98	-	-	-	-	-	-	74,0
102	-	-	-	-	-	-	63,5
106	-	-	-	-	-	-	53,0
110	-	-	-	-	-	-	-

66 m + 60 m

m	t	t	t	t	t	t	t
22	-	233,0*	-	-	-	-	-
24	-	232,0*	-	-	-	-	-
26	155,5	238,0	-	-	-	-	-
28	144,5	238,0	-	-	-	-	229,0
30	135,0	237,0	-	-	-	-	229,0
34	119,0	234,0	-	-	-	-	229,0
38	106,0	228,0	-	-	-	-	229,0
42	94,9	221,0	-	-	-	-	226,0
46	83,0	214,0	-	-	-	-	224,0
48	77,9	210,0	235,0	-	-	-	223,0
50	73,2	202,0	233,0	-	-	-	222,0
54	64,9	186,5	228,0	-	-	-	213,0
58	57,8	168,5	210,0	-	-	-	201,0
62	51,7	150,0	194,0	-	-	-	184,0
66	46,3	127,0	180,0	-	-	-	168,0
70	-	-	166,5	157,5	-	-	154,0
74	-	-	152,0	147,5	-	-	142,0
78	-	-	133,5	138,0	-	-	131,0
82	-	-	-	130,0	-	-	121,0
86	-	-	-	122,5	112,0	-	112,0
90	-	-	-	-	105,0	-	102,0
94	-	-	-	-	99,2	-	91,5
98	-	-	-	-	93,7	-	81,5
102	-	-	-	-	-	73,5	71,5
106	-	-	-	-	-	69,8	66,0
110	-	-	-	-	-	-	58,0
114	-	-	-	-	-	-	49,3
118	-	-	-	-	-	-	41,9

For explanations see page 51 · Bemerkungen siehe Seite 51 · Pour plus de détails, voir page 51 · Per spiegazioni vedere a pagina 51 · Véase p. 51 para más información · Para explicações, ver página 51 · Объяснения см. на стр. 51

170-250 t 0-80 t 15-24 m 9,60 m 9.8 m/s 360° ISO

66 m + 72 m

m	SWSL						SFSL
	0 t		80 t-450 t				
	85°	85°	75°	65°	55°	45°	t
24	-	182,5*	-	-	-	-	-
26	-	182,0*	-	-	-	-	-
28	-	180,5*	-	-	-	-	-
30	126,0	184,5	-	-	-	-	-
34	110,5	182,5	-	-	-	-	178,0
38	98,1	180,0	-	-	-	-	178,0
42	87,7	177,0	-	-	-	-	178,0
46	77,5	173,5	-	-	-	-	178,0
50	68,1	169,5	-	-	-	-	178,0
54	60,1	166,0	177,0	-	-	-	177,0
58	53,3	161,0	176,5	-	-	-	171,0
62	47,4	151,0	175,5	-	-	-	167,0
66	42,2	137,5	174,0	-	-	-	163,0
70	37,7	124,0	162,0	-	-	-	155,0
74	33,6	109,0	149,5	141,5	-	-	143,0
78	29,9	93,0	136,5	132,5	-	-	131,0
82	-	-	125,0	124,5	-	-	121,0
86	-	-	114,5	117,5	-	-	112,0
90	-	-	-	111,0	-	-	104,0
94	-	-	-	105,0	93,5	-	96,5
98	-	-	-	99,6	88,1	-	86,5
102	-	-	-	-	83,1	-	77,5
106	-	-	-	-	78,5	-	69,0
110	-	-	-	-	74,2	61,5	61,0
114	-	-	-	-	-	58,4	56,0
118	-	-	-	-	-	55,6	49,9
122	-	-	-	-	-	-	42,5
126	-	-	-	-	-	-	35,0
130	-	-	-	-	-	-	30,7

66 m + 84 m

m	t	t	t	t	t	t	t
28	-	141,0*	-	-	-	-	-
30	-	140,0*	-	-	-	-	-
32	110,5	141,5	-	-	-	-	-
34	104,0	141,5	-	-	-	-	-
38	92,1	140,0	-	-	-	-	137,0
42	82,1	138,5	-	-	-	-	137,0
46	73,6	136,5	-	-	-	-	137,0
50	65,8	134,5	-	-	-	-	137,0
54	57,9	132,0	-	-	-	-	137,0
58	51,1	130,0	133,5	-	-	-	137,0
62	45,2	127,5	133,5	-	-	-	135,0
66	40,0	125,5	133,5	-	-	-	132,0
70	35,5	123,5	133,0	-	-	-	129,0
74	31,5	115,0	132,5	-	-	-	127,0
78	27,8	105,5	132,0	-	-	-	125,0
82	24,6	95,8	124,0	118,5	-	-	122,0
86	21,6	84,7	114,0	115,0	-	-	113,0
90	-	-	105,0	108,5	-	-	105,0
94	-	-	97,3	102,5	-	-	97,5
98	-	-	89,7	97,4	-	-	90,5
102	-	-	-	92,3	79,8	-	83,5
106	-	-	-	87,7	75,3	-	75,0
110	-	-	-	83,4	71,1	-	67,5
114	-	-	-	-	67,2	-	60,0
118	-	-	-	-	63,5	-	53,0
122	-	-	-	-	60,1	49,1	48,1
126	-	-	-	-	-	46,3	43,5
130	-	-	-	-	-	43,7	37,1
134	-	-	-	-	-	-	30,8
138	-	-	-	-	-	-	25,8

66 m + 96 m

m	SWSL						SFSL
	0 t		80 t-450 t				
	85°	85°	75°	65°	55°	45°	t
30	-	107,0*	-	-	-	-	-
34	-	106,0*	-	-	-	-	-
36	91,3	106,5	-	-	-	-	-
38	86,0	106,5	-	-	-	-	-
42	76,4	105,0	-	-	-	-	104,0
46	68,3	103,5	-	-	-	-	103,0
50	61,2	102,0	-	-	-	-	103,0
54	55,1	100,5	-	-	-	-	103,0
58	48,7	98,8	-	-	-	-	102,0
62	42,8	96,9	97,8	-	-	-	101,0
66	37,6	95,1	97,8	-	-	-	100,0
70	33,1	93,2	97,8	-	-	-	98,0
74	29,0	91,1	97,7	-	-	-	96,5
78	25,4	88,7	97,2	-	-	-	95,0
82	22,2	86,1	96,5	-	-	-	93,5
86	19,2	83,5	95,4	-	-	-	91,5
90	16,5	81,0	94,5	85,1	-	-	90,0
94	14,1	74,5	93,5	85,1	-	-	88,5
98	11,8	65,9	88,9	85,0	-	-	86,5
102	-	-	82,4	85,0	-	-	84,5
106	-	-	76,4	85,0	-	-	78,0
110	-	-	70,4	81,1	67,8	-	71,5
114	-	-	-	77,1	63,9	-	64,5
118	-	-	-	73,4	60,3	-	58,0
122	-	-	-	69,9	56,9	-	51,5
126	-	-	-	-	53,7	-	45,5
130	-	-	-	-	50,8	40,2	40,7
134	-	-	-	-	-	37,7	37,1
138	-	-	-	-	-	35,4	31,6
142	-	-	-	-	-	33,2	26,1
146	-	-	-	-	-	-	20,6
150	-	-	-	-	-	-	16,7
154	-	-	-	-	-	-	-

* Main boom angle 87° · Hauptauslegerwinkel 87° ·
 Jarret de flèche principale 87° · Inclinazione braccio base 87° ·
 Ângulo de pluma principal 87° · Ângulo da lança principal 87° ·
 Угол подъема пл. стрелы 87°

Main boom angle 87°, 85°, 75°, 65°, 55° and 45°, capacities for intermediate boom positions are calculated by the crane control system IC-1

Hauptauslegerwinkel 87°, 85°, 75°, 65°, 55° und 45°, Traglasten für Zwischenstellungen des Hauptauslegers werden von der Kransteuerung IC-1 berechnet

Jarret de flèche principale 87°, 85°, 75°, 65°, 55° et 45°, le système de commande de la grue IC-1 calcule les charges pour les positions intermédiaires de la flèche

Inclinazione braccio base 87°, 85°, 75°, 65°, 55° e 45°, capacità per posizioni intermedie del braccio sono calcolate dal sistema di controllo della gru IC-1

Ângulo de pluma principal 87°, 85°, 75°, 65°, 55° y 45° las capacidades para posiciones de pluma intermedias son calculadas por el sistema de control de grúa IC-1

Ângulos da lança principal 87°, 85°, 75°, 65°, 55° e 45°; as capacidades para posições da lança intermediária são calculadas pelo sistema de controle da grua IC-1

Грузоподъемность при углах подъема главной стрелы 87°, 85°, 75°, 65°, 55° и 45°, грузоподъемность в промежуточных положениях стрелы рассчитывается системой управления краном IC-1

170-250 t 0-80 t 15-24 m 9,60 m 9.8 m/s 360° ISO

66 m + 108 m

m	SWSL						SFSL
	0 t		80 t-450 t				
	85°	85°	75°	65°	55°	45°	t
32	-	80,2*	-	-	-	-	-
34	-	80,2*	-	-	-	-	-
38	75,8	79,3	-	-	-	-	-
42	70,9	78,8	-	-	-	-	-
46	63,1	77,9	-	-	-	-	77,0
50	56,3	76,8	-	-	-	-	76,5
54	50,4	75,8	-	-	-	-	76,0
58	45,2	74,6	-	-	-	-	75,5
62	40,6	73,3	-	-	-	-	74,5
66	35,4	72,0	-	-	-	-	73,5
70	30,9	70,7	70,3	-	-	-	72,5
74	26,8	69,5	70,3	-	-	-	71,5
78	23,2	68,2	70,2	-	-	-	70,5
82	19,9	66,5	70,1	-	-	-	69,0
86	17,0	64,2	69,8	-	-	-	67,5
90	14,3	61,7	69,3	-	-	-	66,5
94	11,8	59,3	68,9	-	-	-	65,0
98	9,6	56,8	68,2	59,9	-	-	64,0
102	7,5	54,3	67,4	59,9	-	-	62,5
106	5,6	51,9	66,0	59,9	-	-	61,5
110	-	49,4	64,4	59,9	-	-	60,0
114	-	-	62,7	59,9	-	-	58,0
118	-	-	60,2	59,9	-	-	56,0
122	-	-	55,3	59,9	51,9	-	53,5
126	-	-	-	59,9	50,7	-	49,6
130	-	-	-	59,4	47,8	-	43,9
134	-	-	-	55,2	45,0	-	38,4
138	-	-	-	-	42,4	-	34,0
142	-	-	-	-	39,9	29,9	30,7
146	-	-	-	-	-	27,9	26,2
150	-	-	-	-	-	25,9	21,4
154	-	-	-	-	-	24,1	16,5
158	-	-	-	-	-	-	11,7
162	-	-	-	-	-	-	8,7
166	-	-	-	-	-	-	-

* Main boom angle 87° · Hauptauslegerwinkel 87° ·
 Jarret de flèche principale 87° · Inclinazione braccio base 87° ·
 Ángulo de pluma principal 87° · Ángulo da lança principal 87° ·
 Угол подъема гл. стрелы 87°

Main boom angle 87°, 85°, 75°, 65°, 55° and 45°, capacities for intermediate boom positions are calculated by the crane control system IC-1

Hauptauslegerwinkel 87°, 85°, 75°, 65°, 55° und 45°, Traglasten für Zwischenstellungen des Hauptauslegers werden von der Kransteuerung IC-1 berechnet

Jarret de flèche principale 87°, 85°, 75°, 65°, 55° et 45°, le système de commande de la grue IC-1 calcule les charges pour les positions intermédiaires de la flèche

Inclinazione braccio base 87°, 85°, 75°, 65°, 55° e 45°, capacità per posizioni intermedie del braccio sono calcolate dal sistema di controllo della gru IC-1

Ángulo de pluma principal 87°, 85°, 75°, 65°, 55° y 45° las capacidades para posiciones de pluma intermedias son calculadas por el sistema de control de grúa IC-1

Ángulos da lança principal 87°, 85°, 75°, 65°, 55° e 45°, as capacidades para posições da lança intermediária são calculadas pelo sistema de controle da grua IC-1

Грузоподъемность при углах подъема главной стрелы 87°, 85°, 75°, 65°, 55° и 45°, грузоподъемность в промежуточных положениях стрелы рассчитывается системой управления краном IC-1

72 m + 36 m

m	SWSL						SFSL
	0 t		80 t-450 t				
	85°	85°	75°	65°	55°	45°	t
16	-	346,0*	-	-	-	-	-
18	-	343,0*	-	-	-	-	-
20	216,0	355,0	-	-	-	-	336,0
22	198,0	353,0	-	-	-	-	336,0
24	182,5	347,0	-	-	-	-	336,0
26	169,5	339,0	-	-	-	-	336,0
28	157,5	331,0	-	-	-	-	336,0
30	147,5	323,0	-	-	-	-	331,0
34	126,0	307,0	-	-	-	-	327,0
38	108,5	274,0	-	-	-	-	324,0
40	101,0	254,0	317,0	-	-	-	308,5
42	94,7	237,0	301,0	-	-	-	293,0
44	88,5	222,0	286,0	-	-	-	277,0
46	-	-	271,0	-	-	-	261,0
50	-	-	247,0	-	-	-	234,0
54	-	-	226,0	-	-	-	211,0
58	-	-	-	195,5	-	-	191,0
62	-	-	-	180,5	-	-	174,0
66	-	-	-	168,0	-	-	159,0
70	-	-	-	-	-	-	145,0
74	-	-	-	-	136,5	-	133,0
78	-	-	-	-	128,0	-	121,0
82	-	-	-	-	-	-	107,0
86	-	-	-	-	-	-	94,5
90	-	-	-	-	-	-	83,0
94	-	-	-	-	-	-	75,5
98	-	-	-	-	-	-	63,5

72 m + 48 m

m	t	t	t	t	t	t	t
19	-	274,0*	-	-	-	-	-
20	-	274,0*	-	-	-	-	-
22	-	270,0*	-	-	-	-	-
24	171,5	281,0	-	-	-	-	266,0
26	159,0	279,0	-	-	-	-	266,0
28	148,0	276,0	-	-	-	-	266,0
30	138,5	271,0	-	-	-	-	266,0
34	122,0	262,0	-	-	-	-	266,0
38	106,0	251,0	-	-	-	-	262,0
42	92,1	241,0	-	-	-	-	259,0
44	86,2	230,0	279,0	-	-	-	255,0
46	80,8	223,0	269,0	-	-	-	253,0
50	71,3	198,5	244,0	-	-	-	237,0
54	63,4	178,0	223,0	-	-	-	214,0
58	-	-	205,0	-	-	-	194,0
62	-	-	190,0	-	-	-	177,0
66	-	-	176,5	165,0	-	-	161,0
70	-	-	-	153,5	-	-	147,0
74	-	-	-	144,0	-	-	135,0
78	-	-	-	135,0	-	-	124,0
82	-	-	-	-	117,0	-	115,0
86	-	-	-	-	110,5	-	104,0
90	-	-	-	-	104,0	-	93,0
94	-	-	-	-	-	-	82,5
98	-	-	-	-	-	-	72,0
102	-	-	-	-	-	-	65,5
106	-	-	-	-	-	-	57,5
110	-	-	-	-	-	-	47,9
114	-	-	-	-	-	-	-

170-250 t 0-80 t 15-24 m 9,60 m 9.8 m/s 360° ISO

72 m + 60 m

m	SWSL						SFSL
	0 t		80 t-450 t				
	85°	85°	75°	65°	55°	45°	t
22	-	217,0*	-	-	-	-	-
24	-	216,0*	-	-	-	-	-
26	149,0	221,0	-	-	-	-	-
28	139,0	221,0	-	-	-	-	212,0
30	129,5	220,0	-	-	-	-	212,0
34	114,5	217,0	-	-	-	-	212,0
38	101,5	212,0	-	-	-	-	212,0
42	91,4	205,0	-	-	-	-	212,0
46	81,3	199,0	-	-	-	-	209,0
50	71,6	192,5	220,0	-	-	-	207,0
54	63,5	181,5	217,0	-	-	-	199,0
58	56,5	170,5	207,0	-	-	-	193,0
62	50,4	153,5	191,0	-	-	-	181,0
66	45,1	131,0	177,5	-	-	-	165,0
70	-	-	165,0	153,0	-	-	151,0
74	-	-	154,5	143,0	-	-	139,0
78	-	-	143,0	134,5	-	-	128,0
82	-	-	-	126,5	-	-	118,0
86	-	-	-	119,0	-	-	109,0
90	-	-	-	112,5	102,0	-	100,0
94	-	-	-	-	96,5	-	93,0
98	-	-	-	-	91,0	-	83,0
102	-	-	-	-	86,0	-	73,5
106	-	-	-	-	-	64,5	64,5
110	-	-	-	-	-	61,3	57,5
114	-	-	-	-	-	-	52,0
118	-	-	-	-	-	-	44,2
122	-	-	-	-	-	-	36,0
126	-	-	-	-	-	-	-

72 m + 72 m

m	t	t	t	t	t	t	t
26	-	170,5*	-	-	-	-	-
28	-	169,5*	-	-	-	-	-
30	120,5	172,5	-	-	-	-	-
34	106,0	171,5	-	-	-	-	167,0
38	94,2	169,5	-	-	-	-	167,0
42	84,1	166,5	-	-	-	-	167,0
46	75,6	163,0	-	-	-	-	167,0
50	66,6	159,5	-	-	-	-	167,0
54	58,7	156,0	167,0	-	-	-	166,0
58	52,0	152,5	166,0	-	-	-	162,0
62	46,2	147,5	165,5	-	-	-	157,0
66	41,1	139,5	164,5	-	-	-	153,0
70	36,6	126,5	159,5	-	-	-	149,0
74	32,5	111,5	149,0	-	-	-	140,0
78	28,9	95,9	140,0	129,0	-	-	129,0
82	-	-	130,0	121,0	-	-	118,0
86	-	-	119,0	114,0	-	-	109,0
90	-	-	105,5	107,5	-	-	101,0
94	-	-	-	102,0	-	-	93,5
98	-	-	-	96,7	85,4	-	86,5
102	-	-	-	91,7	80,5	-	78,5
106	-	-	-	-	76,0	-	70,0
110	-	-	-	-	71,8	-	62,5
114	-	-	-	-	67,9	53,4	54,5
118	-	-	-	-	-	50,7	48,5
122	-	-	-	-	-	48,2	44,2
126	-	-	-	-	-	-	37,5
130	-	-	-	-	-	-	30,6
134	-	-	-	-	-	-	24,6

72 m + 84 m

m	SWSL						SFSL
	0 t		80 t-450 t				
	85°	85°	75°	65°	55°	45°	t
28	-	132,0*	-	-	-	-	-
30	-	131,5*	-	-	-	-	-
34	99,5	133,0	-	-	-	-	-
38	88,1	131,5	-	-	-	-	129,0
42	78,5	130,0	-	-	-	-	129,0
46	70,4	128,5	-	-	-	-	129,0
50	63,4	126,5	-	-	-	-	129,0
54	56,5	124,0	-	-	-	-	129,0
58	49,8	122,0	-	-	-	-	129,0
62	43,9	120,0	125,5	-	-	-	129,0
66	38,9	117,5	125,5	-	-	-	124,0
70	34,4	115,5	125,0	-	-	-	121,0
74	30,4	113,5	124,5	-	-	-	119,0
78	26,8	107,5	124,0	-	-	-	117,0
82	23,6	97,7	123,5	-	-	-	114,0
86	20,7	86,6	118,5	111,5	-	-	110,0
90	18,0	74,7	109,0	105,5	-	-	102,0
94	-	-	100,5	99,7	-	-	94,5
98	-	-	93,2	94,4	-	-	87,5
102	-	-	83,0	89,5	-	-	81,0
106	-	-	-	85,0	72,6	-	75,0
110	-	-	-	80,8	68,5	-	68,0
114	-	-	-	76,9	64,7	-	60,5
118	-	-	-	-	61,1	-	53,5
122	-	-	-	-	57,8	-	47,3
126	-	-	-	-	-	42,1	41,2
130	-	-	-	-	-	40,0	37,3
134	-	-	-	-	-	38,0	32,3
138	-	-	-	-	-	-	26,4
142	-	-	-	-	-	-	20,5
146	-	-	-	-	-	-	15,7

* Main boom angle 87° · Hauptauslegerwinkel 87° ·
 Jarret de flèche principale 87° · Inclinazione braccio base 87° ·
 Ángulo de pluma principal 87° · Ángulo da lança principal 87° ·
 Угол подъема гл. стрелы 87°

Main boom angle 87°, 85°, 75°, 65°, 55° and 45°, capacities for intermediate boom positions are calculated by the crane control system IC-1

Hauptauslegerwinkel 87°, 85°, 75°, 65°, 55° und 45°, Traglasten für Zwischenstellungen des Hauptauslegers werden von der Kransteuerung IC-1 berechnet

Jarret de flèche principale 87°, 85°, 75°, 65°, 55° et 45°, le système de commande de la grue IC-1 calcule les charges pour les positions intermédiaires de la flèche

Inclinazione braccio base 87°, 85°, 75°, 65°, 55° e 45°, capacità per posizioni intermedie del braccio sono calcolate dal sistema di controllo della gru IC-1

Ángulo de pluma principal 87°, 85°, 75°, 65°, 55° y 45° las capacidades para posiciones de pluma intermedias son calculadas por el sistema de control de grúa IC-1

Ángulos da lança principal 87°, 85°, 75°, 65°, 55° e 45°, as capacidades para posições da lança intermediária são calculadas pelo sistema de controle da grua IC-1

Грузоподъемность при углах подъема главной стрелы 87°, 85°, 75°, 65°, 55° и 45°, грузоподъемность в промежуточных положениях стрелы рассчитывается системой управления краном IC-1

170-250 t 0-80 t		15-24 m		9,60 m		9.8 m/s		360°		ISO								
72 m + 96 m						72 m + 108 m												
		SWSL					SFSL			SWSL					SFSL			
		0 t	80 t-450 t								0 t	80 t-450 t						
		85°	85°	75°	65°	55°	45°				85°	85°	75°	65°	55°	45°		
	m	t	t	t	t	t	t	t			m	t	t	t	t	t	t	t
30			101,5*								34		76,3*					
34			100,5*								38		75,2*					
36	87,2	101,0									40	71,2	75,4					
38	82,0	101,0									42	67,4	75,2					
42	72,8	100,0							98,5			46	59,9	74,3				73,5
46	65,0	98,9							98,5			50	53,4	73,4				73,0
50	58,3	97,6							98,5			54	47,7	72,4				72,5
54	52,4	96,0							98,5			58	42,7	71,3				72,5
58	47,2	94,2							97,5			62	38,3	70,2				71,5
62	41,5	92,4							97,0			66	34,2	68,9				70,5
66	36,4	90,7	93,2						96,0			70	29,7	67,7	67,0			70,0
70	32,0	88,9	93,2						94,5			74	25,7	66,5	67,0			69,0
74	28,0	87,0	93,2						92,5			78	22,2	65,2	67,0			67,5
78	24,4	85,1	93,1						91,0			82	18,9	63,8	67,0			66,5
82	21,2	83,1	92,5						89,5			86	16,0	61,9	66,9			65,0
86	18,3	81,2	91,9						88,0			90	13,4	59,8	66,6			64,0
90	15,7	79,2	90,9	80,9					87,0			94	11,0	57,7	66,3			63,0
94	13,2	75,9	90,2	80,9					85,0			98	8,7	55,7	66,0	56,9		62,0
98	11,0	67,4	89,4	80,7					83,5			102	6,7	53,6	65,3	56,9		60,5
102	8,9	58,1	85,3	80,7					81,5			106		51,5	64,5	56,9		59,5
106			79,1	80,7					75,5			110		49,4	63,3	56,8		58,0
110			73,4	78,3					69,5			114			62,0	56,8		57,0
114			65,2	74,5	61,3				64,5			118			60,9	56,8		55,0
118				70,8	57,8				58,0			122			57,9	56,7	49,0	52,5
122				67,5	54,5				51,5			126			51,1	56,7	48,3	49,5
126				64,4	51,4				45,9			130				56,7	45,4	43,9
130					48,5				40,1			134				55,6	42,7	38,5
134						45,8	34,3	34,5				138				53,1	40,2	33,4
138							32,4	30,9				142					37,8	28,5
142								30,5	27,0			146					35,5	25,2
146									28,6	21,8			150					23,3
150										16,7			154					21,6
154										11,4			158					19,9
158										7,6			162					8,1
162													166					

* Main boom angle 87° · Hauptauslegerwinkel 87° · Jarret de flèche principale 87° · Inclinazione braccio base 87° · Ángulo de pluma principal 87° · Ángulo da lança principal 87° · Угол подъема гл. стрелы 87°

Main boom angle 87°, 85°, 75°, 65°, 55° and 45°, capacities for intermediate boom positions are calculated by the crane control system IC-1

Hauptauslegerwinkel 87°, 85°, 75°, 65°, 55° und 45°, Traglasten für Zwischenstellungen des Hauptauslegers werden von der Kransteuerung IC-1 berechnet

Jarret de flèche principale 87°, 85°, 75°, 65°, 55° et 45°, le système de commande de la grue IC-1 calcule les charges pour les positions intermédiaires de la flèche

Inclinazione braccio base 87°, 85°, 75°, 65°, 55° e 45°, capacità per posizioni intermedie del braccio sono calcolate dal sistema di controllo della gru IC-1

Ángulo de pluma principal 87°, 85°, 75°, 65°, 55° y 45° las capacidades para posiciones de pluma intermedias son calculadas por el sistema de control de grúa IC-1

Ángulos da lança principal 87°, 85°, 75°, 65°, 55° e 45°, as capacidades para posições da lança intermediária são calculadas pelo sistema de controle da grua IC-1

Грузоподъемность при углах подъема главной стрелы 87°, 85°, 75°, 65°, 55° и 45°, грузоподъемность в промежуточных положениях стрелы рассчитывается системой управления краном IC-1

170-250 t 0-80 t 15-24 m 9,60 m 9.8 m/s 360° ISO

78 m + 36 m

m	SWSL						SFSL
	0 t		80 t-450 t				
	85°	85°	75°	65°	55°	45°	t
17	-	313,0*	-	-	-	-	-
18	-	313,0*	-	-	-	-	-
20	-	308,0*	-	-	-	-	-
22	190,0	321,0	-	-	-	-	307,0
24	175,5	317,0	-	-	-	-	307,0
26	162,5	312,0	-	-	-	-	307,0
28	151,5	305,0	-	-	-	-	307,0
30	142,0	298,0	-	-	-	-	307,0
34	124,0	284,0	-	-	-	-	303,0
38	106,5	271,0	-	-	-	-	299,0
40	99,4	259,0	312,0	-	-	-	293,0
42	92,8	241,0	296,0	-	-	-	290,0
44	86,7	225,0	282,0	-	-	-	274,0
46	-	-	268,0	-	-	-	258,0
50	-	-	243,0	-	-	-	231,0
54	-	-	222,0	-	-	-	208,0
58	-	-	205,0	190,5	-	-	188,0
62	-	-	-	176,5	-	-	171,0
66	-	-	-	164,0	-	-	156,0
70	-	-	-	153,0	-	-	142,0
74	-	-	-	-	-	-	130,0
78	-	-	-	-	123,5	-	119,0
82	-	-	-	-	116,0	-	109,0
86	-	-	-	-	-	-	97,0
90	-	-	-	-	-	-	85,0
94	-	-	-	-	-	-	74,0
98	-	-	-	-	-	-	66,5
102	-	-	-	-	-	-	57,5
106	-	-	-	-	-	-	-

78 m + 60 m

m	SWSL						SFSL
	0 t		80 t-450 t				
	85°	85°	75°	65°	55°	45°	t
22	-	201,0*	-	-	-	-	-
24	-	200,0*	-	-	-	-	-
26	-	198,5*	-	-	-	-	-
28	133,0	205,0	-	-	-	-	-
30	124,5	204,0	-	-	-	-	196,0
34	110,0	200,0	-	-	-	-	196,0
38	97,9	196,0	-	-	-	-	196,0
42	87,8	190,5	-	-	-	-	196,0
46	79,3	184,5	-	-	-	-	195,0
50	70,1	179,0	203,0	-	-	-	194,0
54	62,0	173,5	201,0	-	-	-	188,0
58	55,1	165,5	200,0	-	-	-	181,0
62	49,2	156,5	188,5	-	-	-	175,0
66	43,9	134,5	174,5	-	-	-	162,0
70	-	-	163,0	-	-	-	149,0
74	-	-	152,0	138,5	-	-	136,0
78	-	-	142,5	130,0	-	-	125,0
82	-	-	-	122,5	-	-	115,0
86	-	-	-	116,0	-	-	106,0
90	-	-	-	109,5	-	-	98,0
94	-	-	-	103,5	92,5	-	90,0
98	-	-	-	-	87,8	-	83,0
102	-	-	-	-	82,9	-	74,5
106	-	-	-	-	78,4	-	66,0
110	-	-	-	-	-	57,5	58,0
114	-	-	-	-	-	54,3	50,0
118	-	-	-	-	-	-	45,4
122	-	-	-	-	-	-	39,0
126	-	-	-	-	-	-	31,5

78 m + 48 m

m	t	t	t	t	t	t	t
19	-	252,0*	-	-	-	-	-
20	-	252,0*	-	-	-	-	-
22	-	249,0*	-	-	-	-	-
24	164,5	257,0	-	-	-	-	-
26	152,5	256,0	-	-	-	-	245,0
28	142,0	253,0	-	-	-	-	245,0
30	133,0	250,0	-	-	-	-	245,0
34	117,5	242,0	-	-	-	-	245,0
38	104,0	233,0	-	-	-	-	245,0
42	90,2	224,0	-	-	-	-	242,0
46	79,0	215,0	255,0	-	-	-	238,0
50	69,7	201,0	241,0	-	-	-	228,0
54	61,8	180,0	220,0	-	-	-	211,0
58	-	-	202,0	-	-	-	191,0
62	-	-	187,5	-	-	-	174,0
66	-	-	174,0	160,5	-	-	158,0
70	-	-	-	149,5	-	-	145,0
74	-	-	-	140,0	-	-	132,0
78	-	-	-	131,5	-	-	121,0
82	-	-	-	123,5	-	-	111,0
86	-	-	-	-	105,5	-	102,0
90	-	-	-	-	100,0	-	94,5
94	-	-	-	-	94,9	-	84,0
98	-	-	-	-	-	-	74,0
102	-	-	-	-	-	-	64,5
106	-	-	-	-	-	-	57,0
110	-	-	-	-	-	-	51,0
114	-	-	-	-	-	-	42,7

78 m + 72 m

m	t	t	t	t	t	t	t
26	-	159,5*	-	-	-	-	-
28	-	158,5*	-	-	-	-	-
30	115,5	161,5	-	-	-	-	-
34	101,5	161,0	-	-	-	-	156,0
38	90,2	159,0	-	-	-	-	156,0
42	80,6	156,5	-	-	-	-	156,0
46	72,4	153,5	-	-	-	-	156,0
50	65,1	150,0	-	-	-	-	156,0
54	57,3	146,5	-	-	-	-	156,0
58	50,7	143,5	156,5	-	-	-	154,0
62	44,9	139,5	156,0	-	-	-	148,0
66	39,9	136,0	154,5	-	-	-	144,0
70	35,5	128,5	153,5	-	-	-	140,0
74	31,5	114,0	147,0	-	-	-	137,0
78	27,9	98,6	137,5	-	-	-	126,0
82	-	-	129,5	118,0	-	-	116,0
86	-	-	122,0	111,0	-	-	107,0
90	-	-	112,0	104,5	-	-	98,5
94	-	-	-	99,1	-	-	91,0
98	-	-	-	93,9	-	-	83,5
102	-	-	-	89,0	77,3	-	77,0
106	-	-	-	-	72,9	-	70,5
110	-	-	-	-	68,9	-	63,0
114	-	-	-	-	65,1	-	55,5
118	-	-	-	-	-	-	48,6
122	-	-	-	-	-	43,5	41,8
126	-	-	-	-	-	41,3	37,4
130	-	-	-	-	-	-	32,4
134	-	-	-	-	-	-	26,1
138	-	-	-	-	-	-	19,7

170-250 t 0-80 t 15-24 m 9,60 m 9.8 m/s 360° ISO

		SWSL						SFSL
		0 t		80 t-450 t				
		85°	85°	75°	65°	55°	45°	
m	t	t	t	t	t	t	t	t
28	-	124,5*	-	-	-	-	-	-
30	-	124,0*	-	-	-	-	-	-
34	95,1	125,0	-	-	-	-	-	-
38	84,2	124,0	-	-	-	-	121,0	-
42	75,0	123,0	-	-	-	-	121,0	-
46	67,2	121,5	-	-	-	-	121,0	-
50	60,5	119,5	-	-	-	-	121,0	-
54	54,6	117,5	-	-	-	-	121,0	-
58	48,4	115,5	-	-	-	-	121,0	-
62	42,7	113,5	119,5	-	-	-	121,0	-
66	37,7	111,5	119,0	-	-	-	118,0	-
70	33,3	109,5	119,0	-	-	-	115,0	-
74	29,3	107,0	118,0	-	-	-	112,0	-
78	25,8	105,0	118,0	-	-	-	110,0	-
82	22,7	99,4	117,0	-	-	-	108,0	-
86	19,8	88,4	117,0	105,5	-	-	106,0	-
90	17,2	76,7	113,0	102,0	-	-	100,0	-
94	-	-	104,0	96,6	-	-	92,0	-
98	-	-	96,4	91,4	-	-	85,0	-
102	-	-	87,8	86,7	-	-	78,5	-
106	-	-	-	82,3	-	-	72,0	-
110	-	-	-	78,2	65,5	-	66,5	-
114	-	-	-	74,4	61,8	-	60,5	-
118	-	-	-	-	58,3	-	54,0	-
122	-	-	-	-	55,1	-	47,6	-
126	-	-	-	-	52,1	-	41,5	-
130	-	-	-	-	-	35,5	35,5	-
134	-	-	-	-	-	33,6	31,3	-
138	-	-	-	-	-	31,8	27,4	-
142	-	-	-	-	-	-	21,9	-
146	-	-	-	-	-	-	16,4	-
150	-	-	-	-	-	-	10,8	-
154	-	-	-	-	-	-	-	-

		SWSL						SFSL
		0 t		80 t-450 t				
		85°	85°	75°	65°	55°	45°	
m	t	t	t	t	t	t	t	t
30	-	95,9*	-	-	-	-	-	-
34	-	95,2*	-	-	-	-	-	-
36	83,2	95,9	-	-	-	-	-	-
38	78,1	95,9	-	-	-	-	-	-
42	69,4	94,9	-	-	-	-	93,0	-
46	61,9	93,8	-	-	-	-	93,0	-
50	55,4	92,5	-	-	-	-	93,0	-
54	49,7	91,1	-	-	-	-	93,0	-
58	44,7	89,4	-	-	-	-	92,5	-
62	40,3	87,8	-	-	-	-	92,0	-
66	35,3	86,1	88,7	-	-	-	91,5	-
70	30,9	84,4	88,7	-	-	-	90,5	-
74	26,9	82,8	88,7	-	-	-	88,5	-
78	23,4	81,2	88,7	-	-	-	87,0	-
82	20,2	79,6	88,2	-	-	-	85,5	-
86	17,4	78,0	87,7	-	-	-	84,5	-
90	14,8	76,4	86,8	-	-	-	83,0	-
94	12,4	74,8	86,4	77,0	-	-	81,5	-
98	10,2	68,8	85,8	76,7	-	-	80,5	-
102	8,2	59,7	84,3	76,7	-	-	79,0	-
106	-	-	81,8	76,7	-	-	73,0	-
110	-	-	75,8	75,1	-	-	67,5	-
114	-	-	69,0	71,3	-	-	62,0	-
118	-	-	-	67,8	54,9	-	57,0	-
122	-	-	-	64,5	51,7	-	51,5	-
126	-	-	-	61,5	48,7	-	45,7	-
130	-	-	-	-	45,9	-	40,0	-
134	-	-	-	-	43,2	-	34,6	-
138	-	-	-	-	40,8	29,0	29,3	-
142	-	-	-	-	-	27,5	26,3	-
146	-	-	-	-	-	25,6	22,2	-
150	-	-	-	-	-	23,8	17,4	-
154	-	-	-	-	-	-	12,6	-
158	-	-	-	-	-	-	7,7	-
162	-	-	-	-	-	-	-	-

* Main boom angle 87° · Hauptauslegerwinkel 87° · Jarret de flèche principale 87° · Inclinazione braccio base 87° · Ángulo de pluma principal 87° · Ángulo da lança principal 87° · Угол подъема гл. стрелы 87°

Main boom angle 87°, 85°, 75°, 65°, 55° and 45°, capacities for intermediate boom positions are calculated by the crane control system IC-1

Hauptauslegerwinkel 87°, 85°, 75°, 65°, 55° und 45°, Traglasten für Zwischenstellungen des Hauptauslegers werden von der Kransteuerung IC-1 berechnet

Jarret de flèche principale 87°, 85°, 75°, 65°, 55° et 45°, le système de commande de la grue IC-1 calcule les charges pour les positions intermédiaires de la flèche

Inclinazione braccio base 87°, 85°, 75°, 65°, 55° e 45°, capacità per posizioni intermedie del braccio sono calcolate dal sistema di controllo della gru IC-1

Ángulo de pluma principal 87°, 85°, 75°, 65°, 55° y 45° las capacidades para posiciones de pluma intermedias son calculadas por el sistema de control de grúa IC-1

Ángulos da lança principal 87°, 85°, 75°, 65°, 55° e 45°, as capacidades para posições da lança intermediária são calculadas pelo sistema de controle da grua IC-1

Грузоподъемность при углах подъема главной стрелы 87°, 85°, 75°, 65°, 55° и 45°, грузоподъемность в промежуточных положениях стрелы рассчитывается системой управления краном IC-1

170-250 t 0-80 t 15-24 m 9,60 m 9.8 m/s 360° ISO

78 m + 108 m

m	SWSL						SFSL
	0 t		80 t-450 t				t
	85°	85°	75°	65°	55°	45°	
34	-	72,1*	-	-	-	-	-
38	-	71,4*	-	-	-	-	-
40	67,3	71,5	-	-	-	-	-
42	63,9	71,4	-	-	-	-	-
46	56,7	70,7	-	-	-	-	69,5
50	50,5	69,8	-	-	-	-	69,5
54	45,0	68,9	-	-	-	-	69,0
58	40,2	67,9	-	-	-	-	69,0
62	35,9	66,8	-	-	-	-	68,5
66	32,1	65,6	-	-	-	-	67,5
70	28,6	64,5	-	-	-	-	67,0
74	24,7	63,3	63,8	-	-	-	66,0
78	21,2	62,1	63,8	-	-	-	65,0
82	18,0	60,8	63,8	-	-	-	63,5
86	15,1	59,3	63,8	-	-	-	62,5
90	12,5	57,6	63,7	-	-	-	61,5
94	10,1	55,9	63,5	-	-	-	60,5
98	7,9	54,2	63,3	-	-	-	59,5
102	5,9	52,5	62,8	54,2	-	-	58,5
106	-	50,8	62,4	54,2	-	-	57,5
110	-	49,1	61,7	54,1	-	-	56,0
114	-	46,2	60,7	54,1	-	-	55,0
118	-	-	59,9	54,1	-	-	54,0
122	-	-	59,2	54,0	-	-	51,5
126	-	-	54,2	54,0	45,5	-	48,6
130	-	-	-	54,0	42,7	-	43,3
134	-	-	-	52,9	40,1	-	38,1
138	-	-	-	50,4	37,6	-	33,1
142	-	-	-	-	35,3	-	28,2
146	-	-	-	-	33,1	-	24,1
150	-	-	-	-	31,0	20,3	21,6
154	-	-	-	-	-	18,7	17,2
158	-	-	-	-	-	17,1	12,9
162	-	-	-	-	-	15,5	8,7
166	-	-	-	-	-	-	-

* Main boom angle 87° · Hauptauslegerwinkel 87° ·
 Jarret de flèche principale 87° · Inclinazione braccio base 87° ·
 Ángulo de pluma principal 87° · Ángulo da lança principal 87° ·
 Угол подъема гл. стрелы 87°

Main boom angle 87°, 85°, 75°, 65°, 55° and 45°, capacities for intermediate boom positions are calculated by the crane control system IC-1

Hauptauslegerwinkel 87°, 85°, 75°, 65°, 55° und 45°, Traglasten für Zwischenstellungen des Hauptauslegers werden von der Kransteuerung IC-1 berechnet

Jarret de flèche principale 87°, 85°, 75°, 65°, 55° et 45°, le système de commande de la grue IC-1 calcule les charges pour les positions intermédiaires de la flèche

Inclinazione braccio base 87°, 85°, 75°, 65°, 55° e 45°, capacità per posizioni intermedie del braccio sono calcolate dal sistema di controllo della gru IC-1

Ángulo de pluma principal 87°, 85°, 75°, 65°, 55° y 45° las capacidades para posiciones de pluma intermedias son calculadas por el sistema de control de grúa IC-1

Ángulos da lança principal 87°, 85°, 75°, 65°, 55° e 45°, as capacidades para posições da lança intermediária são calculadas pelo sistema de controle da grua IC-1

Грузоподъемность при углах подъема главной стрелы 87°, 85°, 75°, 65°, 55° и 45°, грузоподъемность в промежуточных положениях стрелы рассчитывается системой управления краном IC-1

84 m + 36 m

m	SWSL						SFSL
	0 t		80 t-450 t				t
	85°	85°	75°	65°	55°	45°	
17	-	285,0*	-	-	-	-	-
18	-	285,0*	-	-	-	-	-
20	-	281,0*	-	-	-	-	-
22	181,5	292,0	-	-	-	-	279,0
24	168,0	288,0	-	-	-	-	279,0
26	156,0	284,0	-	-	-	-	279,0
28	145,5	278,0	-	-	-	-	279,0
30	136,0	273,0	-	-	-	-	279,0
34	120,5	261,0	-	-	-	-	277,0
38	104,5	251,0	-	-	-	-	272,0
42	90,7	240,0	287,0	-	-	-	268,0
44	84,8	229,0	277,0	-	-	-	261,5
46	-	-	264,0	-	-	-	255,0
50	-	-	239,0	-	-	-	228,0
54	-	-	219,0	-	-	-	205,0
58	-	-	201,0	-	-	-	185,0
62	-	-	-	171,0	-	-	168,0
66	-	-	-	159,5	-	-	152,0
70	-	-	-	148,5	-	-	139,0
74	-	-	-	-	-	-	127,0
78	-	-	-	-	117,5	-	116,0
82	-	-	-	-	110,5	-	106,0
86	-	-	-	-	105,0	-	97,0
90	-	-	-	-	-	-	86,0
94	-	-	-	-	-	-	75,5
98	-	-	-	-	-	-	65,0
102	-	-	-	-	-	-	57,5
106	-	-	-	-	-	-	50,5
110	-	-	-	-	-	-	41,1

84 m + 48 m

m	t	t	t	t	t	t	t
20	-	229,0*	-	-	-	-	-
22	-	227,0*	-	-	-	-	-
24	157,0	233,0	-	-	-	-	-
26	146,0	233,0	-	-	-	-	224,0
28	136,0	231,0	-	-	-	-	224,0
30	127,5	228,0	-	-	-	-	224,0
34	112,5	221,0	-	-	-	-	224,0
38	100,5	214,0	-	-	-	-	224,0
42	88,1	206,0	-	-	-	-	221,0
46	77,0	199,5	-	-	-	-	218,0
48	72,2	196,0	230,0	-	-	-	213,5
50	67,9	192,5	230,0	-	-	-	211,0
54	60,1	180,0	216,0	-	-	-	204,0
58	-	-	199,0	-	-	-	188,0
62	-	-	184,0	-	-	-	170,0
66	-	-	171,0	-	-	-	155,0
70	-	-	159,5	144,5	-	-	141,0
74	-	-	-	135,5	-	-	129,0
78	-	-	-	127,5	-	-	118,0
82	-	-	-	120,0	-	-	108,0
86	-	-	-	-	-	-	99,5
90	-	-	-	-	94,6	-	91,0
94	-	-	-	-	89,7	-	83,5
98	-	-	-	-	-	-	74,0
102	-	-	-	-	-	-	65,0
106	-	-	-	-	-	-	56,5
110	-	-	-	-	-	-	48,6
114	-	-	-	-	-	-	43,9
118	-	-	-	-	-	-	36,5
122	-	-	-	-	-	-	28,6

170-250 t 0-80 t 15-24 m 9,60 m 9.8 m/s 360° ISO

		SWSL						SFSL
		0 t		80 t-450 t				
		85°	85°	75°	65°	55°	45°	
m	t	t	t	t	t	t	t	t
24	-	184,0*	-	-	-	-	-	-
26	-	182,5*	-	-	-	-	-	-
28	127,0	187,5	-	-	-	-	-	-
30	119,0	187,0	-	-	-	-	180,0	-
34	105,0	184,0	-	-	-	-	180,0	-
38	93,6	179,5	-	-	-	-	180,0	-
42	84,0	175,0	-	-	-	-	180,0	-
46	75,8	170,0	-	-	-	-	180,0	-
50	68,4	165,0	-	-	-	-	177,0	-
54	60,4	160,0	185,5	-	-	-	174,0	-
58	53,6	155,5	183,0	-	-	-	169,0	-
62	47,7	150,5	181,5	-	-	-	163,0	-
66	42,6	138,0	172,0	-	-	-	159,0	-
70	-	-	160,0	-	-	-	146,0	-
74	-	-	149,5	-	-	-	133,0	-
78	-	-	140,0	125,5	-	-	122,0	-
82	-	-	132,0	118,0	-	-	112,0	-
86	-	-	-	111,5	-	-	103,0	-
90	-	-	-	105,5	-	-	95,0	-
94	-	-	-	100,0	-	-	87,0	-
98	-	-	-	-	82,6	-	80,0	-
102	-	-	-	-	78,4	-	73,5	-
106	-	-	-	-	74,4	-	66,0	-
110	-	-	-	-	-	-	58,0	-
114	-	-	-	-	-	50,0	50,5	-
118	-	-	-	-	-	47,1	43,2	-
122	-	-	-	-	-	-	38,0	-
126	-	-	-	-	-	-	33,0	-
130	-	-	-	-	-	-	26,1	-
134	-	-	-	-	-	-	19,1	-
138	-	-	-	-	-	-	-	-

		SWSL						SFSL
		0 t		80 t-450 t				
		85°	85°	75°	65°	55°	45°	
m	t	t	t	t	t	t	t	t
26	-	147,5*	-	-	-	-	-	-
28	-	147,0*	-	-	-	-	-	-
30	-	145,5*	-	-	-	-	-	-
32	103,0	150,0	-	-	-	-	-	-
34	97,0	149,0	-	-	-	-	144,0	-
38	86,0	147,0	-	-	-	-	144,0	-
42	76,8	144,5	-	-	-	-	144,0	-
46	69,0	141,5	-	-	-	-	144,0	-
50	62,3	138,5	-	-	-	-	144,0	-
54	55,8	135,0	-	-	-	-	144,0	-
58	49,2	132,0	147,0	-	-	-	142,0	-
62	43,6	128,5	145,5	-	-	-	139,0	-
66	38,6	125,5	145,5	-	-	-	134,0	-
70	34,2	122,0	143,0	-	-	-	131,0	-
74	30,3	116,0	142,0	-	-	-	128,0	-
78	26,8	101,0	135,0	-	-	-	123,0	-
82	-	-	127,0	113,5	-	-	113,0	-
86	-	-	119,5	107,0	-	-	104,0	-
90	-	-	113,0	101,0	-	-	95,5	-
94	-	-	102,5	95,7	-	-	88,0	-
98	-	-	-	90,7	-	-	81,0	-
102	-	-	-	86,0	-	-	74,0	-
106	-	-	-	81,6	68,9	-	68,0	-
110	-	-	-	-	65,0	-	62,0	-
114	-	-	-	-	61,3	-	55,0	-
118	-	-	-	-	58,0	-	48,3	-
122	-	-	-	-	-	-	41,7	-
126	-	-	-	-	-	-	36,5	35,4
130	-	-	-	-	-	-	34,3	31,2
134	-	-	-	-	-	-	-	26,7
138	-	-	-	-	-	-	-	20,8
142	-	-	-	-	-	-	-	14,9
146	-	-	-	-	-	-	-	-

* Main boom angle 87° · Hauptauslegerwinkel 87° · Jarret de flèche principale 87° · Inclinação braccio base 87° · Ángulo de pluma principal 87° · Ángulo da lança principal 87° · Угол подъема гл. стрелы 87°

Main boom angle 87°, 85°, 75°, 65°, 55° and 45°, capacities for intermediate boom positions are calculated by the crane control system IC-1

Hauptauslegerwinkel 87°, 85°, 75°, 65°, 55° und 45°, Traglasten für Zwischenstellungen des Hauptauslegers werden von der Kransteuerung IC-1 berechnet

Jarret de flèche principale 87°, 85°, 75°, 65°, 55° et 45°, le système de commande de la grue IC-1 calcule les charges pour les positions intermédiaires de la flèche

Inclinazione braccio base 87°, 85°, 75°, 65°, 55° e 45°, capacità per posizioni intermedie del braccio sono calcolate dal sistema di controllo della gru IC-1

Ángulo de pluma principal 87°, 85°, 75°, 65°, 55° y 45° las capacidades para posiciones de pluma intermedias son calculadas por el sistema de control de grúa IC-1

Ángulos da lança principal 87°, 85°, 75°, 65°, 55° e 45°, as capacidades para posições da lança intermediária são calculadas pelo sistema de controle da grua IC-1

Грузоподъемность при углах подъема главной стрелы 87°, 85°, 75°, 65°, 55° и 45°, грузоподъемность в промежуточных положениях стрелы рассчитывается системой управления краном IC-1

170-250 t 0-80 t 15-24 m 9,60 m 9.8 m/s 360° ISO

		SWSL						SFSL
		0 t		80 t-450 t				
		85°	85°	75°	65°	55°	45°	
m	t	t	t	t	t	t	t	t
28	-	117,0*	-	-	-	-	-	-
30	-	116,5*	-	-	-	-	-	-
34	90,5	117,5	-	-	-	-	-	-
38	80,1	117,0	-	-	-	-	114,0	-
42	71,3	115,5	-	-	-	-	114,0	-
46	63,8	114,0	-	-	-	-	114,0	-
50	57,3	112,5	-	-	-	-	114,0	-
54	51,7	110,5	-	-	-	-	114,0	-
58	46,7	108,5	-	-	-	-	114,0	-
62	41,3	106,5	112,5	-	-	-	114,0	-
66	36,4	104,5	112,5	-	-	-	112,0	-
70	32,0	102,5	112,0	-	-	-	109,0	-
74	28,2	100,0	111,0	-	-	-	106,0	-
78	24,7	98,0	111,0	-	-	-	103,0	-
82	21,6	95,8	111,0	-	-	-	101,0	-
86	18,8	90,1	110,0	-	-	-	99,5	-
90	16,2	78,6	109,5	97,8	-	-	97,0	-
94	-	-	105,0	92,4	-	-	89,5	-
98	-	-	99,5	87,4	-	-	82,0	-
102	-	-	92,1	82,8	-	-	75,5	-
106	-	-	80,8	78,6	-	-	69,5	-
110	-	-	-	74,7	-	-	63,5	-
114	-	-	-	71,0	57,9	-	58,5	-
118	-	-	-	67,7	54,5	-	52,5	-
122	-	-	-	-	51,4	-	46,7	-
126	-	-	-	-	48,5	-	40,8	-
130	-	-	-	-	45,8	-	35,0	-
134	-	-	-	-	-	29,7	29,5	-
138	-	-	-	-	-	28,2	26,3	-
142	-	-	-	-	-	26,8	21,9	-
146	-	-	-	-	-	-	16,7	-
150	-	-	-	-	-	-	11,6	-
154	-	-	-	-	-	-	6,4	-

		SWSL						SFSL
		0 t		80 t-450 t				
		85°	85°	75°	65°	55°	45°	
m	t	t	t	t	t	t	t	t
32	-	88,9*	-	-	-	-	-	-
34	-	88,2*	-	-	-	-	-	-
38	74,1	88,6	-	-	-	-	-	-
42	65,7	87,8	-	-	-	-	86,0	-
46	58,5	86,8	-	-	-	-	86,0	-
50	52,3	85,6	-	-	-	-	86,0	-
54	46,9	84,3	-	-	-	-	86,0	-
58	42,1	82,7	-	-	-	-	85,5	-
62	37,8	81,0	-	-	-	-	85,0	-
66	34,0	79,4	-	-	-	-	84,5	-
70	29,6	77,8	81,7	-	-	-	84,0	-
74	25,8	76,1	81,7	-	-	-	82,0	-
78	22,3	74,5	81,7	-	-	-	79,5	-
82	19,2	72,9	81,6	-	-	-	78,5	-
86	16,4	71,2	80,8	-	-	-	77,0	-
90	13,8	69,6	80,3	-	-	-	76,0	-
94	11,5	67,9	79,3	-	-	-	74,5	-
98	9,3	66,3	78,7	70,7	-	-	73,5	-
102	7,3	61,3	77,8	70,3	-	-	72,0	-
106	-	-	76,8	70,3	-	-	70,5	-
110	-	-	75,3	70,3	-	-	64,5	-
114	-	-	72,6	67,8	-	-	59,0	-
118	-	-	-	64,4	-	-	54,0	-
122	-	-	-	61,2	47,9	-	49,7	-
126	-	-	-	58,3	45,1	-	44,4	-
130	-	-	-	55,5	42,4	-	38,9	-
134	-	-	-	-	39,8	-	33,7	-
138	-	-	-	-	37,5	-	28,6	-
142	-	-	-	-	35,2	23,6	24,2	-
146	-	-	-	-	-	21,8	21,5	-
150	-	-	-	-	-	20,1	16,9	-
154	-	-	-	-	-	18,5	12,4	-
158	-	-	-	-	-	-	7,9	-

* Main boom angle 87° · Hauptauslegerwinkel 87° · Jarret de flèche principale 87° · Inclinação braccio base 87° · Ángulo de pluma principal 87° · Ángulo da lança principal 87° · Угол подъема гл. стрелы 87°

Main boom angle 87°, 85°, 75°, 65°, 55° and 45°, capacities for intermediate boom positions are calculated by the crane control system IC-1

Hauptauslegerwinkel 87°, 85°, 75°, 65°, 55° und 45°, Traglasten für Zwischenstellungen des Hauptauslegers werden von der Kransteuerung IC-1 berechnet

Jarret de flèche principale 87°, 85°, 75°, 65°, 55° et 45°, le système de commande de la grue IC-1 calcule les charges pour les positions intermédiaires de la flèche

Inclinação braccio base 87°, 85°, 75°, 65°, 55° e 45°, capacità per posizioni intermedie del braccio sono calcolate dal sistema di controllo della gru IC-1

Ángulo de pluma principal 87°, 85°, 75°, 65°, 55° y 45° las capacidades para posiciones de pluma intermedias son calculadas por el sistema de control de grúa IC-1

Ángulos da lança principal 87°, 85°, 75°, 65°, 55° e 45°, as capacidades para posições da lança intermediária são calculadas pelo sistema de controle da grua IC-1

Грузоподъемность при углах подъема главной стрелы 87°, 85°, 75°, 65°, 55° и 45°, грузоподъемность в промежуточных положениях стрелы рассчитывается системой управления краном IC-1

170-250 t 0-80 t 15-24 m 9,60 m 9.8 m/s 360° ISO

		SWSL						SFSL
		0 t		80 t-450 t				
		85°	85°	75°	65°	55°	45°	
m	t	t	t	t	t	t	t	t
34	-	68,0*	-	-	-	-	-	-
38	-	67,3*	-	-	-	-	-	-
40	63,2	67,5	-	-	-	-	-	-
42	60,3	67,5	-	-	-	-	-	-
46	53,4	66,8	-	-	-	-	-	65,5
50	47,4	66,0	-	-	-	-	-	65,5
54	42,2	65,2	-	-	-	-	-	65,5
58	37,6	64,2	-	-	-	-	-	65,0
62	33,5	63,1	-	-	-	-	-	65,0
66	29,8	62,0	-	-	-	-	-	64,0
70	26,5	60,9	-	-	-	-	-	63,5
74	23,5	59,8	60,4	-	-	-	-	63,0
78	20,1	58,7	60,4	-	-	-	-	62,0
82	16,9	57,5	60,4	-	-	-	-	60,5
86	14,1	56,3	60,4	-	-	-	-	59,5
90	11,5	54,9	60,4	-	-	-	-	58,5
94	9,2	53,6	60,3	-	-	-	-	57,5
98	7,1	52,2	60,2	-	-	-	-	56,5
102	5,1	50,9	59,6	51,1	-	-	-	55,5
106	-	49,5	59,4	50,9	-	-	-	54,5
110	-	48,2	59,2	50,9	-	-	-	53,5
114	-	46,8	58,5	50,9	-	-	-	52,5
118	-	-	58,2	50,9	-	-	-	51,5
122	-	-	57,8	50,7	-	-	-	50,0
126	-	-	57,1	50,7	-	-	-	46,0
130	-	-	-	50,7	39,1	-	-	41,8
134	-	-	-	49,9	36,6	-	-	36,8
138	-	-	-	47,5	34,2	-	-	31,9
142	-	-	-	45,2	32,0	-	-	27,1
146	-	-	-	-	29,9	-	-	22,6
150	-	-	-	-	27,9	-	-	19,1
154	-	-	-	-	26,0	15,0	-	15,7
158	-	-	-	-	-	13,5	-	12,1
162	-	-	-	-	-	12,0	-	8,1
166	-	-	-	-	-	10,7	-	-

		SWSL						SFSL
		0 t		80 t-450 t				
		85°	85°	75°	65°	55°	45°	
m	t	t	t	t	t	t	t	t
17	-	260,0*	-	-	-	-	-	-
18	-	260,0*	-	-	-	-	-	-
20	-	256,0*	-	-	-	-	-	-
22	174,0	264,0	-	-	-	-	-	254,0
24	161,0	262,0	-	-	-	-	-	254,0
26	149,5	258,0	-	-	-	-	-	254,0
28	139,5	254,0	-	-	-	-	-	254,0
30	130,5	249,0	-	-	-	-	-	254,0
34	115,5	239,0	-	-	-	-	-	254,0
38	102,0	230,0	-	-	-	-	-	251,0
42	88,6	223,0	-	-	-	-	-	248,0
44	82,8	219,0	258,0	-	-	-	-	241,5
46	-	-	257,0	-	-	-	-	238,0
50	-	-	236,0	-	-	-	-	225,0
54	-	-	216,0	-	-	-	-	202,0
58	-	-	198,5	-	-	-	-	182,0
62	-	-	-	-	-	-	-	164,0
66	-	-	-	154,0	-	-	-	149,0
70	-	-	-	144,0	-	-	-	135,0
74	-	-	-	135,0	-	-	-	123,0
78	-	-	-	-	-	-	-	112,0
82	-	-	-	-	104,5	-	-	103,0
86	-	-	-	-	99,1	-	-	94,0
90	-	-	-	-	-	-	-	86,0
94	-	-	-	-	-	-	-	76,0
98	-	-	-	-	-	-	-	66,0
102	-	-	-	-	-	-	-	56,5
106	-	-	-	-	-	-	-	48,8
110	-	-	-	-	-	-	-	43,6
114	-	-	-	-	-	-	-	35,2
118	-	-	-	-	-	-	-	-

* Main boom angle 87° · Hauptauslegerwinkel 87° · Jarret de flèche principale 87° · Inclinação braccio base 87° · Ángulo de pluma principal 87° · Ángulo da lança principal 87° · Угол подъема гл. стрелы 87°

Main boom angle 87°, 85°, 75°, 65°, 55° and 45°, capacities for intermediate boom positions are calculated by the crane control system IC-1

Hauptauslegerwinkel 87°, 85°, 75°, 65°, 55° und 45°, Traglasten für Zwischenstellungen des Hauptauslegers werden von der Kransteuerung IC-1 berechnet

Jarret de flèche principale 87°, 85°, 75°, 65°, 55° et 45°, le système de commande de la grue IC-1 calcule les charges pour les positions intermédiaires de la flèche

Inclinazione braccio base 87°, 85°, 75°, 65°, 55° e 45°, capacità per posizioni intermedie del braccio sono calcolate dal sistema di controllo della gru IC-1

Ángulo de pluma principal 87°, 85°, 75°, 65°, 55° y 45° las capacidades para posiciones de pluma intermedias son calculadas por el sistema de control de grúa IC-1

Ángulos da lança principal 87°, 85°, 75°, 65°, 55° e 45°, as capacidades para posições da lança intermediária são calculadas pelo sistema de controle da grua IC-1

Грузоподъемность при углах подъема главной стрелы 87°, 85°, 75°, 65°, 55° и 45°, грузоподъемность в промежуточных положениях стрелы рассчитывается системой управления краном IC-1

170-250 t 0-80 t		15-24 m		9,60 m		9.8 m/s		360°		ISO		
90 m + 48 m						90 m + 60 m						
		SWSL					SFSL					
		0 t		80 t-450 t								
		85°	85°	75°	65°	55°	45°					
m	t	t	t	t	t	t	t	t	t			
20	-	209,0*	-	-	-	-	-	-	-			
22	-	208,0*	-	-	-	-	-	-	-			
24	-	206,0*	-	-	-	-	-	-	-			
26	139,5	213,0	-	-	-	-	-	-	204,0			
28	130,5	211,0	-	-	-	-	-	-	204,0			
30	122,0	208,0	-	-	-	-	-	-	204,0			
34	108,0	203,0	-	-	-	-	-	-	204,0			
38	96,4	196,0	-	-	-	-	-	-	204,0			
42	86,0	189,0	-	-	-	-	-	-	204,0			
46	75,1	183,0	-	-	-	-	-	-	202,0			
48	70,4	180,0	210,0	-	-	-	-	-	198,0			
50	66,0	177,5	210,0	-	-	-	-	-	197,0			
54	58,4	171,5	205,0	-	-	-	-	-	189,0			
58	-	-	196,0	-	-	-	-	-	183,0			
62	-	-	181,0	-	-	-	-	-	167,0			
66	-	-	168,0	-	-	-	-	-	152,0			
70	-	-	156,5	139,0	-	-	-	-	138,0			
74	-	-	-	130,5	-	-	-	-	126,0			
78	-	-	-	122,5	-	-	-	-	115,0			
82	-	-	-	115,5	-	-	-	-	105,0			
86	-	-	-	109,0	-	-	-	-	96,0			
90	-	-	-	-	88,9	-	-	-	88,0			
94	-	-	-	-	84,3	-	-	-	80,5			
98	-	-	-	-	80,0	-	-	-	73,5			
102	-	-	-	-	-	-	-	-	65,0			
106	-	-	-	-	-	-	-	-	56,5			
110	-	-	-	-	-	-	-	-	48,8			
114	-	-	-	-	-	-	-	-	41,2			
118	-	-	-	-	-	-	-	-	36,4			
122	-	-	-	-	-	-	-	-	30,5			
126	-	-	-	-	-	-	-	-	23,3			
24	-	169,0*	-	-	-	-	-	-	-			
26	-	167,5*	-	-	-	-	-	-	-			
28	121,5	171,5	-	-	-	-	-	-	-			
30	113,5	171,5	-	-	-	-	-	-	165,0			
34	100,5	168,5	-	-	-	-	-	-	165,0			
38	89,5	164,5	-	-	-	-	-	-	165,0			
42	80,3	160,0	-	-	-	-	-	-	165,0			
46	72,4	155,5	-	-	-	-	-	-	165,0			
50	65,7	150,5	-	-	-	-	-	-	165,0			
54	58,9	146,5	169,5	-	-	-	-	-	163,0			
58	52,2	142,5	168,0	-	-	-	-	-	157,0			
62	46,4	138,5	164,5	-	-	-	-	-	152,0			
66	41,3	134,5	162,0	-	-	-	-	-	147,0			
70	-	-	157,5	-	-	-	-	-	143,0			
74	-	-	147,0	-	-	-	-	-	130,0			
78	-	-	138,0	120,5	-	-	-	-	119,0			
82	-	-	129,5	113,5	-	-	-	-	109,0			
86	-	-	-	107,0	-	-	-	-	100,0			
90	-	-	-	101,0	-	-	-	-	92,0			
94	-	-	-	96,1	-	-	-	-	84,5			
98	-	-	-	91,3	-	-	-	-	77,0			
102	-	-	-	-	73,5	-	-	-	70,5			
106	-	-	-	-	69,8	-	-	-	64,5			
110	-	-	-	-	66,3	-	-	-	57,5			
114	-	-	-	-	-	-	-	-	50,0			
118	-	-	-	-	-	-	-	42,7	43,3			
122	-	-	-	-	-	-	-	40,2	36,6			
126	-	-	-	-	-	-	-	-	31,9			
130	-	-	-	-	-	-	-	-	27,1			
134	-	-	-	-	-	-	-	-	20,8			
138	-	-	-	-	-	-	-	-	14,4			

* Main boom angle 87° · Hauptauslegerwinkel 87° · Jarret de flèche principale 87° · Inclinazione braccio base 87° · Ángulo de pluma principal 87° · Ángulo da lança principal 87° · Угол подъема гл. стрелы 87°

Main boom angle 87°, 85°, 75°, 65°, 55° and 45°, capacities for intermediate boom positions are calculated by the crane control system IC-1

Hauptauslegerwinkel 87°, 85°, 75°, 65°, 55° und 45°, Traglasten für Zwischenstellungen des Hauptauslegers werden von der Kransteuerung IC-1 berechnet

Jarret de flèche principale 87°, 85°, 75°, 65°, 55° et 45°, le système de commande de la grue IC-1 calcule les charges pour les positions intermédiaires de la flèche

Inclinazione braccio base 87°, 85°, 75°, 65°, 55° e 45°, capacità per posizioni intermedie del braccio sono calcolate dal sistema di controllo della gru IC-1

Ángulo de pluma principal 87°, 85°, 75°, 65°, 55° y 45° las capacidades para posiciones de pluma intermedias son calculadas por el sistema de control de grúa IC-1

Ángulos da lança principal 87°, 85°, 75°, 65°, 55° e 45°, as capacidades para posições da lança intermediária são calculadas pelo sistema de controle da grua IC-1

Грузоподъемность при углах подъема главной стрелы 87°, 85°, 75°, 65°, 55° и 45°, грузоподъемность в промежуточных положениях стрелы рассчитывается системой управления краном IC-1

170-250 t 0-80 t 15-24 m 9,60 m 9.8 m/s 360° ISO

90 m + 72 m

m	SWSL						SFSL
	0 t		80 t-450 t				
	85°	85°	75°	65°	55°	45°	
26	-	135,5*	-	-	-	-	-
28	-	135,0*	-	-	-	-	-
30	-	134,0*	-	-	-	-	-
32	98,4	137,5	-	-	-	-	-
34	92,3	137,0	-	-	-	-	132,0
38	81,9	135,5	-	-	-	-	132,0
42	73,1	133,0	-	-	-	-	132,0
46	65,6	130,0	-	-	-	-	132,0
50	59,2	127,0	-	-	-	-	132,0
54	53,5	123,5	-	-	-	-	132,0
58	47,8	120,5	134,5	-	-	-	132,0
62	42,2	117,5	134,5	-	-	-	129,0
66	37,3	114,5	133,0	-	-	-	125,0
70	33,0	112,0	132,5	-	-	-	121,0
74	29,2	109,0	129,5	-	-	-	119,0
78	25,7	103,0	128,0	-	-	-	116,0
82	-	-	124,5	-	-	-	110,0
86	-	-	117,5	102,5	-	-	101,0
90	-	-	111,0	97,0	-	-	93,0
94	-	-	105,0	91,7	-	-	85,0
98	-	-	-	86,8	-	-	78,0
102	-	-	-	82,3	-	-	71,5
106	-	-	-	78,2	-	-	65,5
110	-	-	-	74,5	60,8	-	59,5
114	-	-	-	-	57,3	-	54,0
118	-	-	-	-	54,1	-	47,4
122	-	-	-	-	51,1	-	41,2
126	-	-	-	-	-	-	35,1
130	-	-	-	-	-	30,5	29,2
134	-	-	-	-	-	29,0	26,1
138	-	-	-	-	-	-	21,0
142	-	-	-	-	-	-	15,6
146	-	-	-	-	-	-	10,2

90 m + 84 m

m	SWSL						SFSL
	0 t		80 t-450 t				
	85°	85°	75°	65°	55°	45°	
28	-	108,5*	-	-	-	-	-
30	-	108,5*	-	-	-	-	-
34	86,0	109,5	-	-	-	-	-
38	76,0	109,0	-	-	-	-	106,0
42	67,7	108,0	-	-	-	-	106,0
46	60,5	106,5	-	-	-	-	106,0
50	54,3	105,0	-	-	-	-	106,0
54	48,9	102,5	-	-	-	-	106,0
58	44,1	100,5	-	-	-	-	106,0
62	39,9	98,7	-	-	-	-	106,0
66	35,1	96,5	105,5	-	-	-	106,0
70	30,8	94,4	105,0	-	-	-	102,0
74	27,0	92,3	105,0	-	-	-	99,5
78	23,6	90,2	104,0	-	-	-	96,5
82	20,6	88,1	103,5	-	-	-	94,5
86	17,8	86,0	102,0	-	-	-	93,0
90	15,2	80,4	101,0	-	-	-	91,0
94	-	-	100,0	88,3	-	-	87,0
98	-	-	97,5	83,5	-	-	79,5
102	-	-	92,5	79,0	-	-	73,0
106	-	-	85,7	74,9	-	-	67,0
110	-	-	-	71,1	-	-	61,0
114	-	-	-	67,6	-	-	55,5
118	-	-	-	64,4	50,6	-	50,5
122	-	-	-	61,3	47,6	-	45,5
126	-	-	-	-	44,8	-	39,7
130	-	-	-	-	42,2	-	34,2
134	-	-	-	-	-	39,8	28,8
138	-	-	-	-	-	-	24,4
142	-	-	-	-	-	-	22,6
146	-	-	-	-	-	-	20,9
150	-	-	-	-	-	-	11,7
154	-	-	-	-	-	-	6,9

* Main boom angle 87° · Hauptauslegerwinkel 87° · Jarret de flèche principale 87° · Inclinazione braccio base 87° · Ângulo de pluma principal 87° · Ângulo da lança principal 87° · Угол подъема гл. стрелы 87°

Main boom angle 87°, 85°, 75°, 65°, 55° and 45°, capacities for intermediate boom positions are calculated by the crane control system IC-1

Hauptauslegerwinkel 87°, 85°, 75°, 65°, 55° und 45°, Traglasten für Zwischenstellungen des Hauptauslegers werden von der Kransteuerung IC-1 berechnet

Jarret de flèche principale 87°, 85°, 75°, 65°, 55° et 45°, le système de commande de la grue IC-1 calcule les charges pour les positions intermédiaires de la flèche

Inclinazione braccio base 87°, 85°, 75°, 65°, 55° e 45°, capacità per posizioni intermedie del braccio sono calcolate dal sistema di controllo della gru IC-1

Ângulo de pluma principal 87°, 85°, 75°, 65°, 55° y 45° las capacidades para posiciones de pluma intermedias son calculadas por el sistema de control de grúa IC-1

Ângulos da lança principal 87°, 85°, 75°, 65°, 55° e 45°, as capacidades para posições da lança intermediária são calculadas pelo sistema de controle da grua IC-1

Грузоподъемность при углах подъема главной стрелы 87°, 85°, 75°, 65°, 55° и 45°, грузоподъемность в промежуточных положениях стрелы рассчитывается системой управления краном IC-1

170-250 t 0-80 t 15-24 m 9,60 m 9.8 m/s 360° ISO

		SWSL						SFSL
		0 t		80 t-450 t				
		85°	85°	75°	65°	55°	45°	
m	t	t	t	t	t	t	t	t
32	-	83,2*	-	-	-	-	-	-
34	-	82,9*	-	-	-	-	-	-
38	70,1	83,1	-	-	-	-	-	-
42	62,1	82,6	-	-	-	-	80,5	-
46	55,2	81,7	-	-	-	-	80,5	-
50	49,3	80,6	-	-	-	-	80,5	-
54	44,1	79,3	-	-	-	-	80,5	-
58	39,5	77,8	-	-	-	-	80,5	-
62	35,4	76,3	-	-	-	-	80,0	-
66	31,7	74,7	-	-	-	-	79,5	-
70	28,4	73,2	77,1	-	-	-	79,5	-
74	24,6	71,7	77,1	-	-	-	78,0	-
78	21,2	70,1	77,1	-	-	-	76,0	-
82	18,1	68,6	77,1	-	-	-	73,5	-
86	15,4	67,1	76,4	-	-	-	72,5	-
90	12,9	65,6	76,0	-	-	-	71,0	-
94	10,5	64,1	75,6	-	-	-	70,0	-
98	8,4	62,6	74,4	66,6	-	-	68,5	-
102	6,5	61,1	73,8	66,2	-	-	67,0	-
106	-	-	73,1	66,2	-	-	66,0	-
110	-	-	71,5	66,2	-	-	62,0	-
114	-	-	70,7	64,3	-	-	56,5	-
118	-	-	67,4	61,1	-	-	51,5	-
122	-	-	-	58,0	-	-	47,2	-
126	-	-	-	55,2	41,2	-	42,8	-
130	-	-	-	52,5	38,7	-	37,6	-
134	-	-	-	50,0	36,3	-	32,4	-
138	-	-	-	-	34,0	-	27,5	-
142	-	-	-	-	31,8	-	22,7	-
146	-	-	-	-	29,8	-	18,6	-
150	-	-	-	-	-	15,6	15,1	-
154	-	-	-	-	-	14,1	11,7	-
158	-	-	-	-	-	12,7	7,5	-
162	-	-	-	-	-	-	-	-
166	-	-	-	-	-	-	-	-
170	-	-	-	-	-	-	-	-
174	-	-	-	-	-	-	-	-

		SWSL						SFSL
		0 t		80 t-450 t				
		85°	85°	75°	65°	55°	45°	
m	t	t	t	t	t	t	t	t
34	-	63,7*	-	-	-	-	-	-
38	-	63,2*	-	-	-	-	-	-
40	59,0	63,3	-	-	-	-	-	-
42	56,7	63,3	-	-	-	-	-	-
46	50,1	62,8	-	-	-	-	61,5	-
50	44,4	62,1	-	-	-	-	61,5	-
54	39,4	61,3	-	-	-	-	61,5	-
58	35,0	60,4	-	-	-	-	61,0	-
62	31,0	59,4	-	-	-	-	61,0	-
66	27,5	58,3	-	-	-	-	60,5	-
70	24,3	57,3	-	-	-	-	60,0	-
74	21,4	56,2	56,9	-	-	-	59,5	-
78	18,8	55,1	56,9	-	-	-	59,0	-
82	15,9	54,1	56,9	-	-	-	57,5	-
86	13,1	53,0	56,9	-	-	-	56,0	-
90	10,6	52,0	56,9	-	-	-	55,0	-
94	8,3	50,9	56,8	-	-	-	54,0	-
98	6,2	49,8	56,8	-	-	-	53,0	-
102	-	48,8	56,3	-	-	-	52,5	-
106	-	47,7	56,3	47,9	-	-	51,5	-
110	-	46,7	56,1	47,9	-	-	50,5	-
114	-	45,6	55,6	47,9	-	-	50,0	-
118	-	-	54,9	47,9	-	-	49,2	-
122	-	-	54,6	47,6	-	-	48,0	-
126	-	-	54,3	47,6	-	-	43,5	-
130	-	-	52,9	47,6	-	-	39,4	-
134	-	-	-	46,9	32,9	-	35,1	-
138	-	-	-	44,6	30,7	-	30,4	-
142	-	-	-	42,4	28,5	-	25,8	-
146	-	-	-	-	26,5	-	21,3	-
150	-	-	-	-	24,6	-	17,1	-
154	-	-	-	-	22,8	-	12,9	-
158	-	-	-	-	21,1	9,1	9,8	-
162	-	-	-	-	-	7,8	6,7	-
166	-	-	-	-	-	6,6	-	-
170	-	-	-	-	-	5,4	-	-
174	-	-	-	-	-	-	-	-

* Main boom angle 87° · Hauptauslegerwinkel 87° · Jarret de flèche principale 87° · Inclinazione braccio base 87° · Ángulo de pluma principal 87° · Ángulo da lança principal 87° · Угол подъема гл. стрелы 87°

Main boom angle 87°, 85°, 75°, 65°, 55° and 45°, capacities for intermediate boom positions are calculated by the crane control system IC-1

Hauptauslegerwinkel 87°, 85°, 75°, 65°, 55° und 45°, Traglasten für Zwischenstellungen des Hauptauslegers werden von der Kransteuerung IC-1 berechnet

Jarret de flèche principale 87°, 85°, 75°, 65°, 55° et 45°, le système de commande de la grue IC-1 calcule les charges pour les positions intermédiaires de la flèche

Inclinazione braccio base 87°, 85°, 75°, 65°, 55° e 45°, capacità per posizioni intermedie del braccio sono calcolate dal sistema di controllo della gru IC-1

Ángulo de pluma principal 87°, 85°, 75°, 65°, 55° y 45° las capacidades para posiciones de pluma intermedias son calculadas por el sistema de control de grúa IC-1

Ángulos da lança principal 87°, 85°, 75°, 65°, 55° e 45°, as capacidades para posições da lança intermediária são calculadas pelo sistema de controle da grua IC-1

Грузоподъемность при углах подъема главной стрелы 87°, 85°, 75°, 65°, 55° и 45°, грузоподъемность в промежуточных положениях стрелы рассчитывается системой управления краном IC-1

170-250 t 0-80 t		15-24 m		9,60 m		9.8 m/s		360°		ISO		
96 m + 36 m						96 m + 48 m						
		SWSL					SFSL					
		0 t		80 t-450 t								
		85°	85°	75°	65°	55°	45°					
m	t	t	t	t	t	t	t	t	t			
18	-	234,0*	-	-	-	-	-	-	-			
20	-	232,0*	-	-	-	-	-	-	-			
22	165,5	238,0	-	-	-	-	-	230,0	-			
24	153,5	238,0	-	-	-	-	-	230,0	-			
26	142,5	234,0	-	-	-	-	-	230,0	-			
28	133,0	230,0	-	-	-	-	-	230,0	-			
30	125,0	226,0	-	-	-	-	-	230,0	-			
34	110,5	217,0	-	-	-	-	-	230,0	-			
38	99,0	209,0	-	-	-	-	-	230,0	-			
42	86,4	202,0	-	-	-	-	-	227,0	-			
46	75,3	195,0	230,0	-	-	-	-	221,0	-			
50	-	-	226,0	-	-	-	-	211,0	-			
54	-	-	212,0	-	-	-	-	198,0	-			
58	-	-	195,0	-	-	-	-	178,0	-			
62	-	-	180,0	-	-	-	-	161,0	-			
66	-	-	-	147,5	-	-	-	146,0	-			
70	-	-	-	138,0	-	-	-	132,0	-			
74	-	-	-	129,5	-	-	-	120,0	-			
78	-	-	-	122,0	-	-	-	109,0	-			
82	-	-	-	-	-	-	-	99,5	-			
86	-	-	-	-	92,7	-	-	90,5	-			
90	-	-	-	-	87,8	-	-	82,0	-			
94	-	-	-	-	-	-	-	74,5	-			
98	-	-	-	-	-	-	-	65,5	-			
102	-	-	-	-	-	-	56,8	56,5	-			
106	-	-	-	-	-	-	53,5	48,2	-			
110	-	-	-	-	-	-	-	40,2	-			
114	-	-	-	-	-	-	-	36,1	-			
118	-	-	-	-	-	-	-	28,4	-			
122	-	-	-	-	-	-	-	-	-			
126	-	-	-	-	-	-	-	-	-			
20	-	190,0*	-	-	-	-	-	-	-			
22	-	190,0*	-	-	-	-	-	-	-			
24	-	187,5*	-	-	-	-	-	-	-			
26	133,0	193,0	-	-	-	-	-	-	186,0			
28	124,0	192,0	-	-	-	-	-	-	186,0			
30	116,5	190,0	-	-	-	-	-	-	186,0			
34	103,0	184,5	-	-	-	-	-	-	186,0			
38	92,0	178,0	-	-	-	-	-	-	186,0			
42	82,8	172,0	-	-	-	-	-	-	186,0			
46	73,0	166,0	-	-	-	-	-	-	183,0			
50	64,1	161,0	189,0	-	-	-	-	-	181,0			
54	56,5	155,5	187,5	-	-	-	-	-	176,0			
58	-	-	182,0	-	-	-	-	-	169,0			
62	-	-	177,5	-	-	-	-	-	164,0			
66	-	-	165,0	-	-	-	-	-	149,0			
70	-	-	153,5	-	-	-	-	-	135,0			
74	-	-	143,5	125,0	-	-	-	-	123,0			
78	-	-	-	117,0	-	-	-	-	112,0			
82	-	-	-	110,5	-	-	-	-	102,0			
86	-	-	-	104,0	-	-	-	-	93,0			
90	-	-	-	98,9	-	-	-	-	84,5			
94	-	-	-	-	78,3	-	-	-	77,0			
98	-	-	-	-	74,2	-	-	-	70,0			
102	-	-	-	-	70,6	-	-	-	63,0			
106	-	-	-	-	-	-	-	-	55,5			
110	-	-	-	-	-	-	-	-	47,9			
114	-	-	-	-	-	-	-	-	40,7			
118	-	-	-	-	-	-	-	-	33,8			
122	-	-	-	-	-	-	-	-	30,3			
126	-	-	-	-	-	-	-	-	23,8			
130	-	-	-	-	-	-	-	-	17,3			

* Main boom angle 87° · Hauptauslegerwinkel 87° · Jarret de flèche principale 87° · Inclinação braccio base 87° · Ángulo de pluma principal 87° · Ángulo da lança principal 87° · Угол подъема гл. стрелы 87°

Main boom angle 87°, 85°, 75°, 65°, 55° and 45°, capacities for intermediate boom positions are calculated by the crane control system IC-1

Hauptauslegerwinkel 87°, 85°, 75°, 65°, 55° und 45°, Traglasten für Zwischenstellungen des Hauptauslegers werden von der Kransteuerung IC-1 berechnet

Jarret de flèche principale 87°, 85°, 75°, 65°, 55° et 45°, le système de commande de la grue IC-1 calcule les charges pour les positions intermédiaires de la flèche

Inclinação braccio base 87°, 85°, 75°, 65°, 55° e 45°, capacità per posizioni intermedie del braccio sono calcolate dal sistema di controllo della gru IC-1

Ángulo de pluma principal 87°, 85°, 75°, 65°, 55° y 45° las capacidades para posiciones de pluma intermedias son calculadas por el sistema de control de grúa IC-1

Ángulos da lança principal 87°, 85°, 75°, 65°, 55° e 45°, as capacidades para posições da lança intermediária são calculadas pelo sistema de controle da grua IC-1

Грузоподъемность при углах подъема главной стрелы 87°, 85°, 75°, 65°, 55° и 45°, грузоподъемность в промежуточных положениях стрелы рассчитывается системой управления краном IC-1

170-250 t 0-80 t 15-24 m 9,60 m 9.8 m/s 360° ISO

96 m + 60 m

m	SWSL						SFSL
	0 t		80 t-450 t				
	85°	85°	75°	65°	55°	45°	t
24	-	154,5*	-	-	-	-	-
26	-	153,0*	-	-	-	-	-
28	-	151,5*	-	-	-	-	-
30	108,0	156,5	-	-	-	-	150,0
34	95,6	153,5	-	-	-	-	150,0
38	85,1	150,0	-	-	-	-	150,0
42	76,3	145,5	-	-	-	-	150,0
46	68,9	141,5	-	-	-	-	150,0
50	62,4	137,0	-	-	-	-	150,0
54	56,8	133,0	-	-	-	-	148,0
58	50,5	129,0	152,5	-	-	-	146,0
62	44,8	125,5	150,5	-	-	-	140,0
66	39,8	121,5	148,0	-	-	-	136,0
70	-	-	143,5	-	-	-	132,0
74	-	-	140,5	-	-	-	127,0
78	-	-	135,0	-	-	-	116,0
82	-	-	127,0	108,5	-	-	106,0
86	-	-	-	102,0	-	-	97,0
90	-	-	-	96,8	-	-	89,0
94	-	-	-	91,6	-	-	81,0
98	-	-	-	86,9	-	-	74,0
102	-	-	-	-	68,0	-	67,5
106	-	-	-	-	64,5	-	61,5
110	-	-	-	-	61,3	-	55,5
114	-	-	-	-	58,0	-	48,9
118	-	-	-	-	-	-	42,2
122	-	-	-	-	-	35,1	35,8
126	-	-	-	-	-	32,9	29,5
130	-	-	-	-	-	-	26,3
134	-	-	-	-	-	-	20,7
138	-	-	-	-	-	-	14,9
142	-	-	-	-	-	-	9,1
146	-	-	-	-	-	-	-

96 m + 72 m

m	SWSL						SFSL
	0 t		80 t-450 t				
	85°	85°	75°	65°	55°	45°	t
26	-	124,5*	-	-	-	-	-
28	-	123,5*	-	-	-	-	-
30	-	122,5*	-	-	-	-	-
32	93,3	125,5	-	-	-	-	-
34	87,5	125,0	-	-	-	-	121,0
38	77,6	123,5	-	-	-	-	121,0
42	69,3	121,0	-	-	-	-	121,0
46	62,1	118,5	-	-	-	-	121,0
50	55,9	115,0	-	-	-	-	121,0
54	50,5	112,0	-	-	-	-	121,0
58	45,8	109,0	-	-	-	-	121,0
62	40,7	106,0	121,0	-	-	-	119,0
66	35,9	103,5	121,0	-	-	-	116,0
70	31,7	100,5	119,5	-	-	-	111,0
74	27,9	97,9	118,0	-	-	-	108,0
78	24,5	95,2	115,5	-	-	-	105,0
82	-	-	112,5	-	-	-	103,0
86	-	-	110,5	-	-	-	98,5
90	-	-	108,5	92,3	-	-	90,0
94	-	-	102,5	87,2	-	-	82,5
98	-	-	-	82,5	-	-	75,0
102	-	-	-	78,2	-	-	68,5
106	-	-	-	74,2	-	-	62,5
110	-	-	-	70,6	-	-	56,5
114	-	-	-	-	52,6	-	51,5
118	-	-	-	-	49,5	-	45,6
122	-	-	-	-	46,6	-	39,6
126	-	-	-	-	43,9	-	33,7
130	-	-	-	-	-	-	28,1
134	-	-	-	-	-	24,5	23,6
138	-	-	-	-	-	22,7	19,5
142	-	-	-	-	-	-	14,9
146	-	-	-	-	-	-	9,9

* Main boom angle 87° · Hauptauslegerwinkel 87° · Jarret de flèche principale 87° · Inclinazione braccio base 87° · Ângulo de pluma principal 87° · Ângulo da lança principal 87° · Угол подъема гл. стрелы 87°

Main boom angle 87°, 85°, 75°, 65°, 55° and 45°, capacities for intermediate boom positions are calculated by the crane control system IC-1

Hauptauslegerwinkel 87°, 85°, 75°, 65°, 55° und 45°, Traglasten für Zwischenstellungen des Hauptauslegers werden von der Kransteuerung IC-1 berechnet

Jarret de flèche principale 87°, 85°, 75°, 65°, 55° et 45°, le système de commande de la grue IC-1 calcule les charges pour les positions intermédiaires de la flèche

Inclinazione braccio base 87°, 85°, 75°, 65°, 55° e 45°, capacità per posizioni intermedie del braccio sono calcolate dal sistema di controllo della gru IC-1

Ângulo de pluma principal 87°, 85°, 75°, 65°, 55° y 45° las capacidades para posiciones de pluma intermedias son calculadas por el sistema de control de grúa IC-1

Ângulos da lança principal 87°, 85°, 75°, 65°, 55° e 45°, as capacidades para posições da lança intermediária são calculadas pelo sistema de controle da grua IC-1

Грузоподъемность при углах подъема главной стрелы 87°, 85°, 75°, 65°, 55° и 45°, грузоподъемность в промежуточных положениях стрелы рассчитывается системой управления краном IC-1

170-250 t 0-80 t		15-24 m		9,60 m		9.8 m/s		360°		ISO							
96 m + 84 m						96 m + 96 m											
		SWSL					SFSL			SWSL					SFSL		
		0 t	80 t-450 t								80 t-450 t						
		85°	85°	75°	65°	55°	45°				85°	85°	75°	65°	55°	45°	
		m	t	t	t	t	t	t			m	t	t	t	t	t	t
		30	-	99,9*	-	-	-	-			32	-	77,7*	-	-	-	-
		34	-	98,4*	-	-	-	-			34	-	77,4*	-	-	-	-
		36	76,3	100,5	-	-	-	-			38	65,9	77,6	-	-	-	-
		38	71,7	100,5	-	-	-	-			42	58,3	77,2	-	-	-	75,0
		42	63,8	99,2	-	-	-	-			46	51,7	76,4	-	-	-	75,0
		46	57,0	97,7	-	-	-	-			50	46,1	75,4	-	-	-	75,0
		50	51,0	95,9	-	-	-	-			54	41,1	74,2	-	-	-	75,0
		54	45,9	93,9	-	-	-	-			58	36,7	72,8	-	-	-	75,0
		58	41,3	91,7	-	-	-	-			62	32,8	71,3	-	-	-	75,0
		62	37,3	89,6	-	-	-	-			66	29,2	69,9	-	-	-	74,5
		66	33,6	87,4	96,5	-	-	-			70	26,1	68,4	72,1	-	-	74,5
		70	29,5	85,4	96,5	-	-	-			74	23,2	66,9	72,1	-	-	74,0
		74	25,8	83,3	95,9	-	-	-			78	20,0	65,5	72,1	-	-	71,5
		78	22,4	81,3	95,7	-	-	-			82	17,0	64,1	72,1	-	-	69,5
		82	19,4	79,2	94,0	-	-	-			86	14,3	62,7	71,6	-	-	67,5
		86	16,7	77,2	93,1	-	-	-			90	11,8	61,3	71,2	-	-	66,0
		90	14,2	75,1	92,2	-	-	-			94	9,5	59,9	70,9	-	-	64,5
		94	-	-	89,6	82,7	-	-			98	7,5	58,4	70,0	-	-	63,5
		98	-	-	88,1	79,1	-	-			102	5,5	57,0	69,2	61,5	-	62,0
		102	-	-	86,6	74,8	-	-			106	-	-	68,4	61,5	-	60,5
		106	-	-	85,1	70,9	-	-			110	-	-	67,6	61,5	-	59,5
		110	-	-	-	67,2	-	-			114	-	-	65,8	60,5	-	54,0
		114	-	-	-	63,8	-	-			118	-	-	65,0	57,4	-	49,1
		118	-	-	-	60,7	-	-			122	-	-	-	54,5	-	44,4
		122	-	-	-	57,8	43,0	-			126	-	-	-	51,7	-	40,0
		126	-	-	-	-	40,4	-			130	-	-	-	49,1	34,3	35,4
		130	-	-	-	-	37,9	-			134	-	-	-	46,7	32,0	30,4
		134	-	-	-	-	35,6	-			138	-	-	-	-	29,9	25,6
		138	-	-	-	-	33,4	-			142	-	-	-	-	27,9	21,0
		142	-	-	-	-	-	17,2	17,7			146	-	-	-	25,9	16,5
		146	-	-	-	-	-	15,7	14,0			150	-	-	-	24,1	12,2
		150	-	-	-	-	-	14,3	10,5			154	-	-	-	-	9,1
		154	-	-	-	-	-	-	6,1			158	-	-	-	-	7,8
		158	-	-	-	-	-	-	-			162	-	-	-	-	6,6
		162	-	-	-	-	-	-	-			166	-	-	-	-	-

* Main boom angle 87° · Hauptauslegerwinkel 87° · Jarret de flèche principale 87° · Inclinazione braccio base 87° · Ángulo de pluma principal 87° · Ángulo da lança principal 87° · Угол подъема гл. стрелы 87°

Main boom angle 87°, 85°, 75°, 65°, 55° and 45°, capacities for intermediate boom positions are calculated by the crane control system IC-1

Hauptauslegerwinkel 87°, 85°, 75°, 65°, 55° und 45°, Traglasten für Zwischenstellungen des Hauptauslegers werden von der Kransteuerung IC-1 berechnet

Jarret de flèche principale 87°, 85°, 75°, 65°, 55° et 45°, le système de commande de la grue IC-1 calcule les charges pour les positions intermédiaires de la flèche

Inclinazione braccio base 87°, 85°, 75°, 65°, 55° e 45°, capacità per posizioni intermedie del braccio sono calcolate dal sistema di controllo della gru IC-1

Ángulo de pluma principal 87°, 85°, 75°, 65°, 55° y 45° las capacidades para posiciones de pluma intermedias son calculadas por el sistema de control de grúa IC-1

Ángulos da lança principal 87°, 85°, 75°, 65°, 55° e 45°, as capacidades para posições da lança intermediária são calculadas pelo sistema de controle da grua IC-1

Грузоподъемность при углах подъема главной стрелы 87°, 85°, 75°, 65°, 55° и 45°, грузоподъемность в промежуточных положениях стрелы рассчитывается системой управления краном IC-1

170-250 t 0-80 t 15-24 m 9,60 m 9.8 m/s 360° ISO

96 m + 108 m

m	SWSL						SFSL
	0 t		80 t-450 t				
	85°	85°	75°	65°	55°	45°	t
34	-	59,4*	-	-	-	-	-
38	-	58,9*	-	-	-	-	-
42	52,9	58,9	-	-	-	-	-
46	46,7	58,6	-	-	-	-	57,0
50	41,2	57,9	-	-	-	-	57,0
54	36,4	57,1	-	-	-	-	57,0
58	32,2	56,3	-	-	-	-	57,0
62	28,4	55,4	-	-	-	-	57,0
66	25,0	54,4	-	-	-	-	56,5
70	21,9	53,4	-	-	-	-	56,0
74	19,2	52,3	-	-	-	-	55,5
78	16,7	51,3	53,1	-	-	-	55,0
82	14,3	50,3	53,1	-	-	-	54,0
86	12,0	49,3	53,1	-	-	-	52,5
90	9,6	48,2	53,1	-	-	-	51,0
94	7,3	47,2	53,0	-	-	-	50,5
98	5,2	46,2	53,0	-	-	-	49,6
102	-	45,2	52,6	-	-	-	48,8
106	-	44,1	52,5	-	-	-	48,0
110	-	43,1	52,4	44,5	-	-	47,2
114	-	42,1	52,2	44,5	-	-	46,4
118	-	-	51,3	44,5	-	-	45,6
122	-	-	51,0	44,1	-	-	44,7
126	-	-	50,8	44,1	-	-	40,9
130	-	-	50,5	44,1	-	-	36,7
134	-	-	-	43,7	-	-	32,9
138	-	-	-	41,4	26,5	-	28,2
142	-	-	-	39,1	24,5	-	23,7
146	-	-	-	36,8	22,6	-	19,4
150	-	-	-	-	20,8	-	15,2
154	-	-	-	-	19,1	-	11,2
158	-	-	-	-	17,5	-	7,2
162	-	-	-	-	15,9	-	-

* Main boom angle 87° · Hauptauslegerwinkel 87° · Jarret de flèche principale 87° · Inclinação braccio base 87° · Ángulo de pluma principal 87° · Ángulo da lança principal 87° · Угол подъема гл. стрелы 87°

Main boom angle 87°, 85°, 75°, 65°, 55° and 45°, capacities for intermediate boom positions are calculated by the crane control system IC-1

Hauptauslegerwinkel 87°, 85°, 75°, 65°, 55° und 45°, Traglasten für Zwischenstellungen des Hauptauslegers werden von der Kransteuerung IC-1 berechnet

Jarret de flèche principale 87°, 85°, 75°, 65°, 55° et 45°, le système de commande de la grue IC-1 calcule les charges pour les positions intermédiaires de la flèche

Inclinação braccio base 87°, 85°, 75°, 65°, 55° e 45°, capacità per posizioni intermedie del braccio sono calcolate dal sistema di controllo della gru IC-1

Ángulo de pluma principal 87°, 85°, 75°, 65°, 55° y 45° las capacidades para posiciones de pluma intermedias son calculadas por el sistema de control de grúa IC-1

Ángulos da lança principal 87°, 85°, 75°, 65°, 55° e 45°, as capacidades para posições da lança intermediária são calculadas pelo sistema de controle da grua IC-1

Грузоподъемность при углах подъема главной стрелы 87°, 85°, 75°, 65°, 55° и 45°, грузоподъемность в промежуточных положениях стрелы рассчитывается системой управления краном IC-1

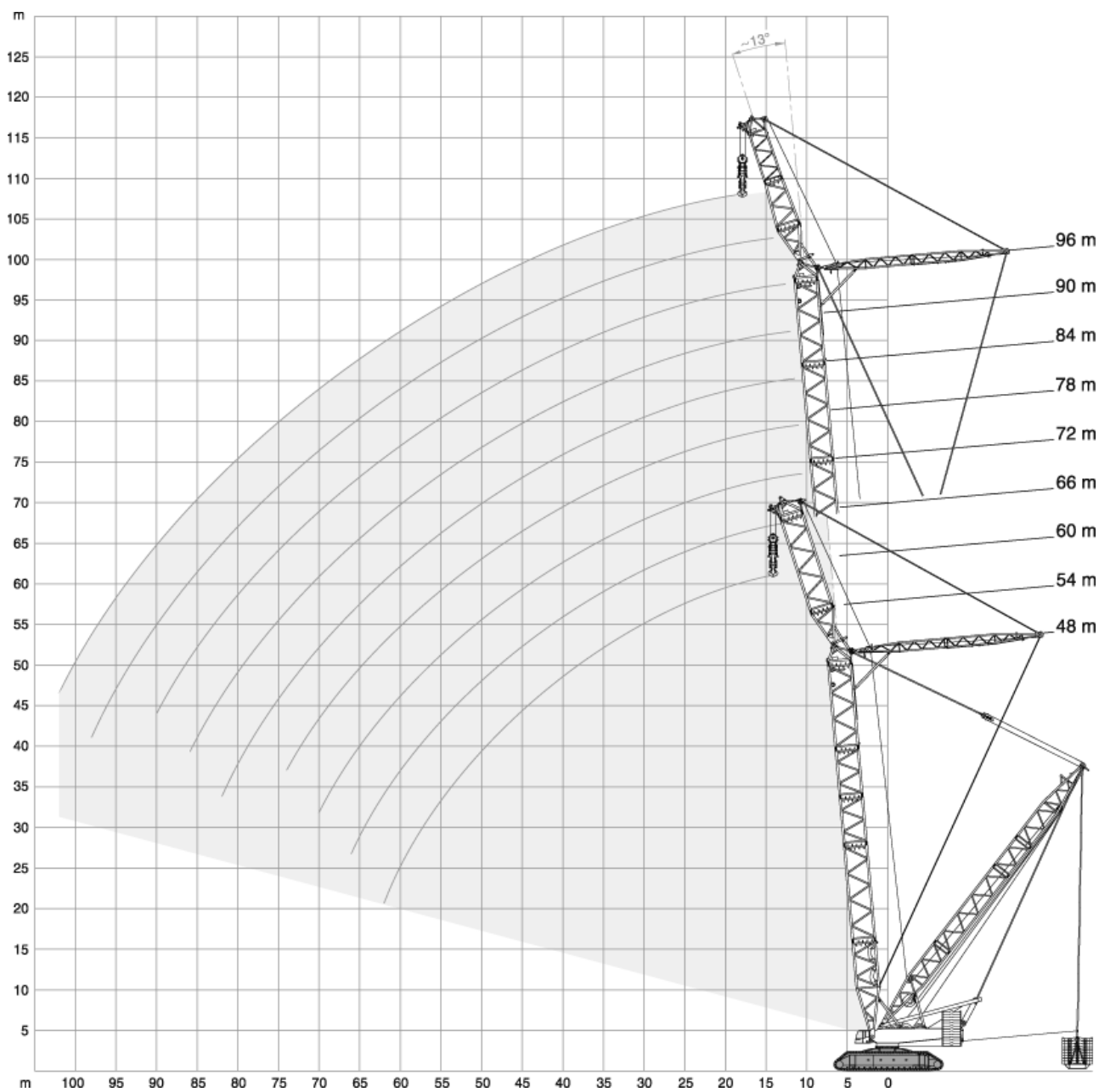

		48 m		54 m		60 m		66 m		72 m		78 m		96 m		
		LFVL	SFVL	LFVL	SFVL	LFVL	SFVL	LFVL	SFVL	LFVL	SFVL	LFVL	LFVL	LFVL	LFVL	
m	t	t	t	t	t	t	t	t	t	t	t	t	t	t	t	m
14	506,0	-	-	-	-	-	-	-	-	-	-	-	-	-	-	14
15	506,0	752,0	506,0	679,0	506,0	-	-	-	-	-	-	-	-	-	-	15
16	506,0	743,0	506,0	679,0	506,0	620,0	506,0	561,0	506,0	-	-	-	-	-	-	16
17	506,0	726,0	506,0	671,0	506,0	612,0	506,0	561,0	506,0	504,0	458,0	412,0	-	-	-	17
18	506,0	702,0	506,0	671,0	506,0	612,0	506,0	561,0	506,0	504,0	458,0	412,0	371,0	-	-	18
19	506,0	679,0	506,0	661,0	506,0	603,0	506,0	552,0	506,0	504,0	458,0	412,0	371,0	333,0	19	19
20	506,0	658,0	506,0	643,0	506,0	603,0	506,0	552,0	506,0	497,0	458,0	412,0	371,0	333,0	20	20
22	506,0	609,0	506,0	605,0	506,0	595,0	506,0	543,0	506,0	495,0	458,0	412,0	371,0	333,0	22	22
24	506,0	554,0	506,0	550,0	506,0	546,0	506,0	535,0	495,0	488,0	451,0	411,0	371,0	333,0	24	24
26	501,0	507,0	504,0	503,0	501,0	499,0	506,0	495,0	487,0	480,0	444,0	405,0	371,0	333,0	26	26
28	480,0	467,0	476,0	463,0	473,0	459,0	470,0	455,0	466,0	451,0	439,0	399,0	365,0	333,0	28	28
30	444,0	432,0	441,0	428,0	437,0	423,0	434,0	420,0	431,0	415,0	427,0	395,0	360,0	328,0	30	30
34	387,0	374,0	383,0	370,0	379,0	365,0	376,0	362,0	373,0	357,0	369,0	366,0	356,0	325,0	34	34
38	341,0	328,0	337,0	324,0	333,0	320,0	330,0	316,0	326,0	311,0	323,0	319,0	316,0	312,0	38	38
42	295,0	281,0	300,0	287,0	296,0	282,0	293,0	279,0	289,0	274,0	286,0	282,0	279,0	275,0	42	42
46	253,0	240,0	269,0	256,0	265,0	252,0	262,0	248,0	258,0	243,0	255,0	251,0	247,0	244,0	46	46
50	220,0	211,0	235,0	221,0	239,0	226,0	236,0	222,0	232,0	217,0	229,0	225,0	221,0	218,0	50	50
54	194,0	182,0	204,0	190,0	216,0	201,0	213,0	200,0	210,0	195,0	206,0	202,0	199,0	195,0	54	54
58	165,0	154,0	178,0	169,0	188,0	174,0	193,0	180,0	190,0	177,0	187,0	183,0	180,0	176,0	58	58
62	146,0	135,0	158,0	146,0	164,0	150,0	171,0	157,0	173,0	160,0	170,0	167,0	163,0	159,0	62	62
66	-	-	134,0	123,0	146,0	136,0	150,0	136,0	156,0	141,0	156,0	152,0	148,0	144,0	66	66
70	-	-	-	-	127,0	115,0	132,0	122,0	137,0	122,0	141,0	139,0	135,0	131,0	70	70
74	-	-	-	-	-	-	118,0	106,0	119,0	107,0	125,0	127,0	124,0	120,0	74	74
78	-	-	-	-	-	-	-	-	108,0	96,5	109,0	112,0	113,0	110,0	78	78
82	-	-	-	-	-	-	-	-	93,5	81,0	97,5	98,5	100,0	100,0	82	82
86	-	-	-	-	-	-	-	-	-	-	86,5	86,5	88,0	88,5	86	86
90	-	-	-	-	-	-	-	-	-	-	-	78,0	76,0	77,0	90	90
94	-	-	-	-	-	-	-	-	-	-	-	-	69,5	66,5	94	94
98	-	-	-	-	-	-	-	-	-	-	-	-	59,0	59,5	98	98
102	-	-	-	-	-	-	-	-	-	-	-	-	-	51,0	102	102
106	-	-	-	-	-	-	-	-	-	-	-	-	-	-	106	106

Crawler Carrier

	3-section carrier comprising of carbody with folded outriggers for the transport and two crawlers. Hydraulic pin connections between crawlers and carbody provide for easy assembly and removal to minimise width and weight for transportation.
Center pot	Bending- and torsion-resistant welded structure fabricated from high-strength fine grain structural steel.
Crawler side frames	Bending-resistant welded structure fabricated from high-strength fine grain structural steel. Centralized lubrication included as standard.
Crawlers	15 track rollers with hardened rolling surfaces. Raised position for both drive sprockets and idler wheels, drive sprockets and idler wheels provide load bearing capacity for erection, adjustable track tension. Each crawler is infinitely variable controlled, both independently and in opposite direction.
Power train	The tracks are powered by two hydraulic motors each through closed planetary gear units running in oil bath, equipped with spring-applied hydraulically released holding brakes. The gear units are of extremely compact design to fit within the width of the crawlers. Each crawler is infinitely variable controlled, both independently and in opposite direction. Quadro-Drive as standard.
Central ballast	80 t.

Superstructure

Counterweight	250 t.
Frame	Bending- and torsion-resistant welded structure fabricated from high-strength fine grain structural steel.
Drive	Two redundant operating water-cooled 6-cylinder MTU diesel engine type OM 460 LA, 2 x 315 kW (428 HP) at 1800 1/min. The engine complies with EUROMOT 3b, Tier 4i and CARB regulations. Fuel tank capacity: 1500 l.
Rope drums	The standard superstructure equipment includes three rope drums – hoist 1, hoist 2 and boom hoist. The drums are powered by hydraulic motors through closed planetary gear units running in oil bath. All rope drums have spring-applied, hydraulically released multi-disk brakes and non-wearing hydraulic braking for load lowering. Rope ends H 1, 2, 3 and W 1, 2 equipped with quick-connect rope end fittings. Hoists H 1 and H 2 and A-frame with boom hoist are removable to minimise weight for transportation.
A-frame	Cylinders on superstructure to raise A-frame are included as standard.
Slew units	Powered by four hydraulic motors through closed, planetary gear unit running in oil bath. Spring-applied, hydraulically released holding brake and non-wearing hydraulic braking.
Control system	IC-1: Electronic proportional valve pilot control integrated in stored-program control system incl. diagnostics. Two colour monitors, load indicator operated via a touchscreen. Working speeds infinitely variable controlled by the lever position. Automatic power control for optimal utilisation of engine output. Standard working range limitation, ground pressure indicator as well as outrigger loading indicator.
Cabin	Comfortable cab with large windscreen and air-conditioning. Laminated glass all around, roof window, self-contained hot air heater, full instrumentation and crane controls. The cab can be tilted back for improved operator view of boom point. A camera system is installed to monitor the rope drums. For transportation, the cab swings in front of the superstructure to minimise width.
Electrical equipment	24 V system (2 batteries 12 V / 180 Ah).
Quick-connection	Hydraulic quick-disconnect fittings on carrier and superstructure facilitate removal to minimise weight for transportation as standard.

Optional equipment

Hydraulic cylinder A-frame	For self-assembly of crawlers.
Sideways outriggers	For erection of long boom systems.
Counterweight carrier	Total weight max. 450 t, in combination with SL telescopic system.
PC outriggers	Outrigger base 14 x 14 m. Alternatively to the crawlers.

Further options on request!

Boom configurations S and L

SH:	Main boom: foot section 12 m, inserts 6 m, 10.5 m and 12 m (type 3328), boom head 1.5 m. Main boom lengths: 36-96 m.
SH / LH: (SGL variable)	Main boom: foot sections 12 m, inserts 6 m, 10.5 m and 12 m (type 3328), tapered insert, extended by inserts 6 m and 12 m (type 2822), top section 7.5 m. Main boom lengths: 48-108 m.
LH:	Main boom: foot section 12 m, insert 10.5 m (type 3328), tapered insert, extended by inserts 6 m and 12 m (type 2822), top section 7.5 m. Main boom lengths: 48-114 m.
SW:	Main boom: same as SH. Offset 87° to 65°. Luffing fly jib: foot section 4.5 m, insert 12 m (type 3328), tapered insert, insert 6 m and inserts 12 m (type 2822), top section 7.5 m. Main boom lengths: 42-60 m. Fly jib lengths: 30-96 m.
SSL:	Main boom: same as SH. Superlift equipment. Main boom lengths: 42-96 m.
SSL / LSL: (SGL 94.5 m)	Main boom: foot section 12 m, inserts 6 m, 10.5 m and 12 m (type 2822), tapered insert, extended by inserts 6 m and 12 m (type 2822), top section 7.5 m. Superlift equipment. Main boom lengths: 102-150 m.
SSL / LSL S1:	Main boom: same as SSL, extended by boom power-kit + jib top section. Main boom lengths: 66-156 m.
SWSL / SFSL:	Main boom: same as SH. Offset 87° to 45°. Luffing fly jib: same as SW. Superlift equipment. Main boom lengths: 48-96 m. Fly jib lengths: 30-108 m.
SFVL:	Main boom: same as SH. Superlift equipment. Fixed jib: foot section 4.5 m, insert 12 m (type 3328), additional SFVL-head included. Main boom lengths: 48-72 m. Fly jib length: 18 m.
LFVL:	Main boom: same as SH. Superlift equipment. Fixed jib: foot section 4.5 m, tapered insert, top section 7.5 m. Main boom lengths: 48-96 m. Fly jib length: 18 m.
+LF:	In addition to main boom configuration SH, SSL, SH/LH, SSL/LSL, SSL/LSL S1. Fly jib lengths: 15 m, 21 m, 27 m, 33 m. Fly jib offset: 15°, 20°, 30°. Runner on LF max. 24 t as standard.
Pinning of boom	Hydraulic assisted pinning of boom sections is standard.
Reeving winch	Mounted on superstructure.
Operator aids	Electronic load indicator, hoist limit switch for boom movements, hydraulic boom backstops, anemometer.

Optional equipment

Power-kit for main boom	Consisting of max. 3 additional boom sections (2 of main boom, 1 of jib); Standard main boom 96 m required.
Standard Superlift equipment	Mast 40.5 m (type 2322), counterweight tray for max. 450 t. Superlift radii 15 m, 18 m, 21 m, 24 m.
Variable Superlift equipment	Mast 40.5 m (type 2322), counterweight tray for max 450 t. Superlift radius infinitely variable during operation 15 to 24 m. Vertical cylinder and stabilising system for Superlift counterweight.
Superlift with counterweight carrier	Mast 40.5 m (type 2322), counterweight carrier for max. 450 t. Superlift radius infinitely variable during operation 18 to 24 m.
Hoist H3	Additional rope drum on main boom (for LF or runner operation). Line pull same as H1, rope length 700 m.
Runner 46 t	Approx. 2 m for installation on boom head or top section.
Fall protection	Fall protection system for main boom, fly jib and superlift mast.

Raupenunterwagen

	Der Raupenunterwagen ist 3-teilig und besteht aus dem Mittelstück mit für den Transport angeklappten Stützträgern und zwei Raupen. Mittelstück und Raupen werden hydraulisch verbolzt und sind einfach demontierbar zum Erreichen günstiger Transportabmessungen und Gewichte.
Mittelstück	Biege- und verwindungssteife Schweißkonstruktion aus hochfestem Feinkornbaustahl.
Raupenträger	Biegesteife Schweißkonstruktion aus hochfestem Feinkornbaustahl. Serienmäßig mit Zentral-Schmierung ausgestattet.
Raupen	15 Laufrollen je Raupenträger mit gehärteten Laufflächen. Jedes Laufwerk wird von Hydromotoren über geschlossene, ölbadgeschmierte Planetengetriebe angetrieben. Jede Seite ist stufenlos einzeln und gegenläufig steuerbar.
Antrieb	Die Raupen werden von je zwei Hydromotoren über geschlossene, ölbadgeschmierte Planetengetriebe mit federbelasteten, hydraulisch gelüfteten Haltebremsen angetrieben. Die Getriebe sind in besonders kompakter Bauform innerhalb der Raupenbreite angeordnet. Jede Seite ist stufenlos, einzeln und gegenläufig steuerbar. Quadro-Antrieb serienmäßig.
Zentralballast	80 t.

Oberwagen

Gegengewicht	250 t.
Rahmen	Biege- und verwindungssteife Schweißkonstruktion aus hochfestem Feinkornbaustahl.
Antrieb	Zwei redundant arbeitende wassergekühlte 6-Zylinder MTU Dieselmotoren Typ OM 460 LA, 2 x 315 kW (428 PS) bei 1800 1/min. Der Motor erfüllt die EUROMOT 3b, Tier 4i und CARB-Vorschriften. Kraftstoffbehälter: 1500 l.
Seilwinden	Der Oberwagen ist serienmäßig mit drei Seilwinden – Hubwerk 1, Hubwerk 2 und Einziehwerk – ausgerüstet. Der Antrieb der Winden erfolgt durch Hydromotoren über geschlossene, ölbadgeschmierte Planetengetriebe. Alle Seilwinden sind mit federbelasteten, hydraulisch gelüfteten Lamellenbremsen und verschleißfreier, hydraulischer Bremsung für den Senkvorgang ausgerüstet. Die Seilenden H 1, 2, 3 und W 1, 2 sind mit Pressfitting und Taschen ausgestattet. Zur Reduzierung der Transportgewichte sind die Winden H 1 und H 2 sowie der A-Bock mit Einziehwerk ausbaubar.
A-Bock	Hydraulikzylinder im Oberwagen für die Umlage des A-Bockes serienmäßig.
Drehwerk	Vier Drehwerke mit Antrieb durch Hydromotor über geschlossenes, ölbadgeschmiertes Planetengetriebe. Federbelastete, hydraulisch löfbbare Haltebremse und verschleißfreie hydraulische Bremse.
Steuerung	IC-1: Elektronische Proportionalventilvorsteuerung integriert in eine speicherprogrammierte Steuerung mit Fehlerdiagnose. Zwei Farbbildschirme, Bedienung über Touchscreen. Die Arbeitsgeschwindigkeiten werden durch die Hebelstellung stufenlos geregelt. Leistungsregelung der Antriebe zur optimalen Nutzung der Motorleistung. Serienmäßig Arbeitsbereichsbegrenzung und Anzeige der Bodenpressung bzw. Stützkräfte.
Kabine	Komfortkabine mit großem Frontfenster und Klimaanlage. Sicherheitsverglasung rundum, Dachfenster, motor-unabhängige Warmluftheizung und Steuer- und Kontrollelementen für die Kranfunktionen. Die Kabine ist zur Sichtverbesserung nach hinten neigbar. Zur Überwachung der Winden im Oberwagen ist ein Kamerasystem installiert. Während des Transportes ist die Kabine vor den Oberwagen geschwenkt.
Elektrische Anlage	Betriebsspannung 24 V (2 Batterien 12 V / 180 Ah).
Quick-connection	Hydraulische Schnellverbindung Unterwagen / Oberwagen zur Reduzierung der Transportgewichte serienmäßig.

Zusatzrüstung

Zylinder am A-Bock	Zur Raupenträger-Selbstmontage.
Zusatzabstützung seitlich	Zum Aufrichten langer Auslegersysteme.
Gegengewichtswagen	Zulässiges Gesamtgewicht 450 t, in Verbindung mit Teleskop-SL-Einrichtung.
PC-Stützen	Stützbasis 14 x 14 m. Zur Verwendung alternativ zu den Raupen.

Weitere Zusatzausrüstungen auf Anfrage!

Auslegervarianten S und L

SH:	Hauptausleger: Fußstück 12 m, Zwischenstücke 6 m, 10,5 m und 12 m (Typ 3328), Anschlusskopf 1,5 m. Hauptauslegerlängen: 36-96 m.
SH / LH: (SGL variabel)	Hauptausleger: Fußstück 12 m, Zwischenstücke 6 m, 10,5 m und 12 m (Typ 3328), Reduzierstück, verlängert um Zwischenstücke 6 m und 12 m (Typ 2822), Spitze 7,5 m. Hauptauslegerlängen: 48-108 m.
LH:	Hauptausleger: Fußstück 12 m, Zwischenstück 10,5 m (Typ 3328), Reduzierstück, verlängert um Zwischenstücke 6 m und 12 m (Typ 2822), Spitze 7,5 m. Hauptauslegerlängen: 48-114 m.
SW:	Hauptausleger: wie SH. Vorneigung 87° bis 65°. Wippbarer Hilfsausleger: Fußstück 4,5 m, Zwischenstück 12 m (Typ 3328), Reduzierstück, Zwischenstück 6 m und Zwischenstücke 12 m (Typ 2822), Spitze 7,5 m. Hauptauslegerlängen: 42-60 m. Hilfsauslegerlängen: 30-96 m.
SSL:	Hauptausleger: wie SH. Superlift-Einrichtung. Hauptauslegerlängen: 42-96 m.
SSL / LSL: (SGL 94,5 m)	Hauptausleger: Fußstück 12 m, Zwischenstücke 6 m, 10,5 m und 12 m (Typ 2822), Reduzierstück, verlängert um Zwischenstücke 6 m und 12 m (Typ 2822), Spitze 7,5 m. Superlift-Einrichtung. Hauptauslegerlängen: 102-150 m.
SSL / LSL S1:	Hauptausleger wie SSL, erweitert mit Verstärkungs-Kit + Hilfsauslegerspitze. Hauptauslegerlängen: 66-156 m.
SWSL / SFSL:	Hauptausleger: wie SH. Vorneigung 87° bis 45°. Wippbarer Hilfsausleger: wie SW. Superlift-Einrichtung. Hauptauslegerlängen: 48-96 m. Hilfsauslegerlängen: 30-108 m.
SFVL:	Hauptausleger: wie SH. Superlift-Einrichtung. Starrer Hilfsausleger: Fußstück 4,5 m, Zwischenstück 12 m (Typ 3328), mit zusätzlichem SFVL-Kopf. Hauptauslegerlängen: 48-72 m. Hilfsauslegerlänge: 18 m.
LFVL:	Hauptausleger: wie SH. Superlift-Einrichtung. Starrer Hilfsausleger: Fußstück 4,5 m, Reduzierstück, Spitze 7,5 m. Hauptauslegerlängen: 48-96 m. Hilfsauslegerlänge: 18 m.
+LF:	Zusätzlich zu Hauptausleger SH, SSL, SH/LH, SSL/LSL, SSL/LSL S1. Hilfsauslegerlängen: 15 m, 21 m, 27 m, 33 m. Hilfsauslegerwinkel: 15°, 20°, 30°. Serienmäßig Runner am LF max. 24 t.
Auslegerverbolzung	Serienmäßig hydraulisch verbolzbare Auslegerteile.
Einscherwinde	Auf Oberwagen angebaut.
Sicherheitseinrichtungen	Elektronischer Lastmomentbegrenzer, Hubendschalter, Endschalter für Auslegerbewegungen, hydraulische Ausleger-Rückfallsicherungen, Windmesser.

Zusatzrüstung

Verstärkungs-Kit für Hauptausleger	Bestehend aus max. 3 zusätzlichen Auslegerteilen (2 aus Hauptausleger, 1 aus Hilfsausleger); Standardhauptausleger 96 m erforderlich.
Superlift-Einrichtung Standard	Mast 40,5 m (Typ 2322), Gegengewichtstraverse mit max. 450 t. Superlift-Radien 15 m, 18 m, 21 m, 24 m.
Superlift-Einrichtung Variabel	Mast 40,5 m (Typ 2322), Gegengewichtstraverse mit max. 450 t. Superlift-Radius stufenlos von 15 bis 24 m im Betrieb verstellbar. Vertikalzylinder und Stabilisierungswinde für Superlift-Gegengewicht.
Superlift mit Gegengewichtswagen	Mast 40,5 m (Typ 2322), Gegengewichtswagen mit max. 450 t. Superlift-Radius stufenlos von 18 bis 24 m im Betrieb verstellbar.
Seilwinde H3	Zusätzliche Seilwinde im Hauptausleger (zum Betrieb mit LF oder Runner). Seilzug wie H1, Seillänge 700 m.
Runner 46 t	Ca. 2 m zum Anbau an Kopf oder Spitze.
Absturzsicherung	Absturzsicherung für Hauptausleger, Hilfsausleger, Superliftmast.

Châssis à chenilles

	Le châssis à chenilles consiste en trois parties – deux chenilles et la partie centrale avec les stabilisateurs plié pour le transport. Les chenilles et la partie centrale sont verrouillées hydrauliquement facilitant ainsi le montage et démontage pour diminuer la largeur d'encombrement et le poids de transport.
Partie centrale	Structure mécano-soudée rigide à la flexion et à la torsion, réalisée en acier de construction à grains fins à haute résistance.
Trains de chenille	Structure mécano-soudée rigide à la flexion, réalisée en acier de construction à grains fins à haute résistance. Graissage centralisé automatique inclus de série.
Chenilles	Chaque trains de chenille est équipée de 15 galets d'appui dont les surfaces de roulement sont trempées. Chaque barbotin est entraîné par moteurs hydrauliques avec réducteurs planétaires en carter étanche sous bain d'huile. Chaque côté permet un mouvement réglable sans paliers individuel et dans le sens opposé.
Entraînement	Les barbotins sont entraînés par deux moteurs hydrauliques de chaque côté muni de réducteurs planétaires, sous bain d'huile, en carter étanche, avec freins d'arrêt à commande par ressorts, desserrés hydrauliquement. Grâce à leur compacité extrême, les réducteurs s'intègrent complètement dans la largeur de chenilles. Chaque chenille permet un mouvement individuel et opposé. Entraînement quadro en série.
Lest central	80 t.

Partie supérieure

Contrepoids	250 t.
Charpente	Construction mécano-soudée, rigide à la flexion et à la torsion en acier de construction de haute résistance à grains fins.
Moteur et transmission	Deux moteurs diesel MTU, type OM 460 LA, 6 cylindres, en action avec redondance intégrée et refroidi par eau, 2 x 315 kW (428 CV) à 1800 ¹ /min. Le moteur satisfait aux règlements EUROMOT 3b, Tier 4i et CARB. Réservoir de carburant : 1500 l.
Tambours	L'équipement standard de la partie tournante comprend trois tambours – treuil no 1, no 2 et mécanisme de relevage. Les tambours sont entraînés par des moteurs hydrauliques munis de réducteurs planétaires, sous bain d'huile, en carter étanche. Tous les tambours sont pourvus de freins à disques multiples à commande par ressorts, et desserrés hydrauliquement. Freinage anti-usure hydraulique pour descendre la charge. Les pattes de câbles H 1, 2, 3 et W 1, 2 sont équipées des attaches à jonction rapide. Treuils H 1 et H 2 et chevalet avec mécanisme de relevage sont démontables pour diminuer le poids de transport.
Chevalet	Système de relevage hydraulique à la partie supérieure pour chevalet en série.
Mécanisme d'orientation	Entraîné par quatre moteurs hydrauliques avec réducteur planétaire, sous bain d'huile, en carter étanche. Frein d'arrêt à commande par ressorts, desserré hydrauliquement ainsi que freinage anti-usure hydraulique.
Commande	IC-1 : Pilotage électronique de soupapes proportionnels intégré dans un automate programmable avec diagnostic de dysfonctionnement. Deux écrans couleur, commande du C.E.C. par écran tactile. Les vitesses de travail sont réglées sans paliers par la position du levier. Régulation automatique pour une exploitation optimale de la puissance du moteur. En série limitation de portée, force de pression sur base et indicateur des forces de calage.
Cabine	Cabine confortable avec large pare-brise et climatisation. Vitrage de sécurité, fenêtre de toit, chauffage à air autonome, organes de commande et instruments de contrôle. Cabine inclinable en arrière assurant au grutier une visibilité optimale. Une caméra est installée pour la surveillance des treuils. Pendant le transport, la cabine est basculée à l'avant de la partie tournante.
Installation électrique	Système 24 V (2 accumulateurs 12 V / 180 Ah).
Connexion rapide	Connexion rapide hydraulique entre châssis et partie tournante permettant le démontage facile pour réduire le poids de transport en série.

Equipements optionnels

Cylindre hydraulique pour le chevalet	Pour le montage des trains de chenille.
Stabilisateur latéral additionnel	Pour le montage des flèches longues.
Chariot contrepoids	Poids total max. 450 t, en combinaison avec l'équipement SL télescopique.
Base de calage variante PC	Base de calage 14 x 14 m. Pour l'utilisation alternative aux chenilles.

Équipements optionnels supplémentaires sur demande!

Configurations de flèche S et L

SH :	Flèche principale : pied 12 m, tronçons 6 m, 10,5 m et 12 m (type 3328), tête de flèche 1,5 m. Longueurs de flèche principale : 36-96 m.
SH / LH : (SGL variable)	Flèche principale : pied 12 m, tronçons 6 m, 10,5 m et 12 m (type 3328), tronçon conique, allongée de tronçons 6 m et 12 m (type 2822), tronçon de tête 7,5 m. Longueurs de flèche principale : 48-108 m.
LH :	Flèche principale : pied 12 m, tronçon 10,5 m (type 3328), tronçon conique, allongée de tronçons 6 m and 12 m (type 2822), tronçon de tête 7,5 m. Longueurs de flèche principale : 48-114 m.
SW :	Flèche principale : Identique à SH. Inclinaison 87° jusqu'à 65°. Fléchette volée variable : pied 4,5 m, tronçon 12 m (type 3328), tronçon conique, tronçon 6 m et tronçons 12 m (type 2822), tronçon de tête 7,5 m. Longueurs de flèche principale : 42-60 m. Longueurs de fléchette : 30-96 m.
SSL :	Flèche principale : Identique à SH. Équipement Superlift. Longueurs de flèche principale : 42-96 m.
SSL / LSL : (SGL 94,5 m)	Flèche principale : pied 12 m, tronçons 6 m, 10,5 m et 12 m (type 2822), tronçon conique, allongée de tronçons 6 m et 12 m (type 2822), tronçon de tête 7,5 m. Équipement Superlift. Longueurs de flèche principale : 102-150 m.
SSL / LSL S1 :	Flèche principale : Identique à SSL, complété par kit à fortifier de flèche + tête de fléchette. Longueurs de flèche principale : 66-156 m.
SWSL / SFSL :	Flèche principale : Identique à SH. Inclinaison 87° jusqu'à 45°. Fléchette volée variable : idem SW. Équipement Superlift. Longueurs de flèche principale : 48-96 m. Longueurs de fléchette : 30-108 m.
SFVL :	Flèche principale : Identique à SH. Équipement Superlift. Fléchette fixe : pied 4,5 m, tronçons 12 m (type 3328), SFVL tronçon de tête compris. Longueurs de flèche principale : 48-72 m. Longueur de fléchette : 18 m.
LFVL :	Flèche principale : Identique à SH. Équipement Superlift. Fléchette fixe : pied 4,5 m, tronçon conique, tronçon de tête 7,5 m. Longueurs de flèche principale : 48-96 m. Longueur de fléchette : 18 m.
+LF :	En supplément de la configuration avec flèche principale SH, SSL, SH/LH, SSL/LSL, SSL/LSL S1. Longueurs de fléchette : 15 m, 21 m, 27 m, 33 m. Inclinaison de fléchette : 15°, 20°, 30°. Runner sur LF max. 24 t en équipement standard.
Boulonnement de flèche	Boulonnement hydraulique des intercalaires de flèche en série.
Tambour de mouflage	Monté sur la partie tournante.
Sécurités	Contrôleur d'état de charge électronique, contacteur de fin de course haut, limiteurs de mouvements de la flèche, retenues hydrauliques anti-basculement de la flèche, anémomètre.

Équipements optionnels

Kit à fortifier pour flèche principale	Constitué de max. 3 sections de flèche additionnelles (2 sur flèche principale, 1 sur fléchette) ; flèche principale de 96 m requise.
Équipement Superlift standard	Mât 40,5 m (type 2322), panier du contrepoids pour max. 450 t. Rayons du Superlift 15 m, 18 m, 21 m, 24 m.
Équipement Superlift variable	Mât 40,5 m (type 2322), panier du contrepoids pour max 450 t. Rayon du Superlift variable de 15 à 24 m. Cylindre vertical et système de stabilisation pour le contrepoids Superlift.
Superlift avec chariot contrepoids	Mât 40,5 m (type 2322), chariot contrepoids pour max. 450 t. Rayon du Superlift variable de 18 à 24 m.
Treuil H3	Tambour supplémentaire sur la flèche principale (à utiliser avec LF ou runner). Effort au brin simple idem H1, longueur de câble 700 m.
Runner 46 t	Environ 2 m à installer en tête de flèche ou sur l'élément de pointe.
Protection anti-chute	Système de protection anti-chute pour flèche principale, fléchette à volée variable et mât Superlift.

Carro cingolato

	Carro in 3 sezioni, carrozzeria con spazio per trasporto stabilizzatori in posizione chiusa e due cingoli. Le giunzioni idrauliche a spina tra cingoli e carro facilitano le operazioni di montaggio e smontaggio e consentono di ridurre al minimo la larghezza e il peso in ordine di marcia.
Sezione centrale	Struttura saldata, resistente a torsioni e flessioni, realizzata in acciaio strutturale pregiato a grana fine.
Telai portacingoli	Struttura saldata resistente a flessioni, realizzata in acciaio strutturale pregiato a grana fine. Lubrificazione centralizzata di serie.
Cingoli	15 rulli portacingolo con superficie di rotolamento bonificata. Posizione rialzata per le ruote motrici e tendicingolo. Le due ruote assicurano la capacità portante necessaria per l'erezione del braccio e consentono di regolare il tensionamento dei cingoli. Ogni lato è controllato a regolazione continua, con possibilità di movimento indipendente e di rotazione in direzioni opposte.
Catena cinematica	I cingoli sono azionati da due motori idraulici, ciascuno provvisto di riduttori planetari in bagno d'olio, muniti di carter a tenuta e freno di arresto a molla, ad apertura idraulica. Il design dei riduttori è estremamente compatto e si adatta perfettamente alla larghezza dei cingoli. Ogni lato è controllato a regolazione continua, con possibilità di movimento indipendente e di rotazione in direzioni opposte. Quadro Drive di serie.
Zavorra centrale	80 t.

Torretta

Contrappeso	250 t.
Struttura	Struttura saldata, resistente a torsioni e flessioni, realizzata in acciaio strutturale pregiato a grana fine.
Azionamento	Due motori diesel MTU ridondanti, a 6 cilindri, raffreddati ad acqua, tipo OM 460 LA, 2 x 315 kW (428 HP) a 1800 1/min. Il motore è conforme alle normative EUROMOT 3b, Tier 4i e CARB. Capacità del serbatoio: 1500 l.
Tamburi avvolgimento fune	La dotazione standard della torretta comprende tre tamburi: argano 1, argano 2 e argano del braccio. I tamburi sono azionati da motori idraulici tramite riduttori planetari in bagno d'olio, dotati di carter a tenuta. Tutti i tamburi sono equipaggiati di freni multidisco a molla, ad apertura idraulica e sistema di frenatura idraulica antiusura per la discesa del carico. Le cime delle funi H 1, 2, 3 e W 1, 2 sono dotate di dispositivo a sgancio rapido. Gli argani H 1 e H 2 e la cuspide con l'argano del braccio sono rimovibili, per ridurre il peso durante il trasporto.
Cuspide	Torretta equipaggiata di serie con cilindri per il sollevamento della cuspide.
Ralla	Alimentata da quattro motori idraulici tramite riduttori planetari in bagno d'olio con carter a tenuta. Freno di arresto a molla, frenatura idraulica antiusura, con apertura idraulica.
Sistema di comando	IC-1: Valvola di regolazione proporzionale elettronica integrata nel sistema di controllo software, comprendente funzioni di diagnostica. Monitor bicolore, indicatore di carico con touch-screen. Velocità di lavoro a regolazione continua sulla base della posizione della leva. Controllo automatico dell'alimentazione, per un utilizzo ottimale della potenza erogata dal motore. Limitatore sbraccio standard, indicazione della pressione al suolo, indicazione del carico sugli stabilizzatori.
Cabina	Comoda cabina con ampio parabrezza e climatizzazione. Vetro stratificato panoramico, tettuccio apribile, riscaldatore ad aria calda indipendente, strumentazione e comandi gru completi. La cabina può essere inclinata per incrementare la visibilità dell'operatore sul punto di lavoro del braccio. I tamburi avvolgimento fune sono dotati di videocamera di monitoraggio. Per il trasporto, la cabina ruota sul lato anteriore della torretta, in modo da ridurre la larghezza.
Componenti elettrici	Impianto 24 V (2 batterie 12 V / 180 Ah).
Raccordi rapidi	Raccordi idraulici di accoppiamento rapido di serie su carro e torretta per facilitare lo smontaggio, riducendo al minimo il peso durante il trasporto.

Equipaggiamento opzionale

Cuspide con cilindro idraulico	Per l'autoassemblaggio dei cingoli.
Stabilizzatori laterali	Per l'erezione di bracci lunghi.
Contrappeso carro	Peso totale max. 450 t, in combinazione con sistema telescopico SL.
Stabilizzatori gru su zoccolo	Base stabilizzatori 14 x 14 m. In alternativa ai cingoli.

Ulteriori opzioni su richiesta!

Configurazioni del braccio S e L

SH:	Braccio base: colonna 12 m, elementi 6 m, 10,5 m e 12 m (tipo 3328), testa braccio 1,5 m. Lunghezza del braccio base: 36-96 m.
SH / LH: (SGL variabile)	Braccio base: colonna 12 m, elementi 6 m, 10,5 m e 12 m (tipo 3328), elemento conico, esteso per elementi 6 m e 12 m (tipo 2822), elemento superiore 7,5 m. Lunghezza del braccio base: 48-108 m.
LH:	Braccio base: colonna 12 m, elementi 10,5 m (tipo 3328), elemento conico, esteso per elementi 6 m e 12 m (tipo 2822), elemento superiore 7,5 m. Lunghezza del braccio base: 48-114 m.
SW:	Braccio base: come SH. Inclinazione da 87° a 65°. Falcone a volata variabile: colonna 4,5 m, elemento 12 m (tipo 3328), elemento conico, elemento 6 m ed elementi 12 m (tipo 2822), elemento superiore 7,5 m. Lunghezza del braccio base: 42-60 m. Lunghezze falcone: 30-96 m.
SSL:	Braccio base: come SH. Sistema Superlift. Lunghezza del braccio base: 42-96 m.
SSL / LSL: (SGL 94,5 m)	Braccio base: colonna 12 m, elemento 6 m, 10,5 m e 12 m (tipo 2822), elemento conico, esteso per elementi 6 m e 12 m (tipo 2822), elemento superiore 7,5 m. Sistema Superlift. Lunghezza del braccio base: 102-150 m.
SSL / LSL S1:	Braccio base: come SSL, esteso con kit potenza braccio + elemento superiore falcone. Lunghezza del braccio base: 66-156 m.
SWSL / SFSL:	Braccio base: come SH. Inclinazione da 87° a 45°. Falcone a volata variabile: come SW. Sistema Superlift. Lunghezza del braccio base: 48-96 m. Lunghezze falcone: 30-108 m.
SFVL:	Braccio base: come SH. Sistema Superlift. Falcone rigido: colonna 4,5 m, elemento 12 m (tipo 3328), ulteriore testa SFVL compresa. Lunghezza del braccio base: 48-72 m. Lunghezza falcone: 18 m.
LFVL:	Braccio base: come SH. Sistema Superlift. Falcone rigido: colonna 4,5 m, elemento conico, elemento superiore 7,5 m. Lunghezza del braccio base: 48-96 m. Lunghezza falcone: 18 m.
+LF:	Oltre alla configurazione del braccio base SH, SSL, SH/LH, SSL/LSL, SSL/LSL S1. Lunghezze falcone: 15 m, 21 m, 27 m, 33 m. Inclinazione falcone: 15°, 20°, 30°. Runner su LF max. 24 t di serie.
Fissaggio del braccio base	Fissaggio degli elementi del braccio con servocomando idraulico di serie.
Verricello di avvolgimento	Montato su torretta.
Dispositivi di sicurezza	Indicatore di carico elettronico finecorsa argano per movimenti braccio, dispositivo antiretro braccio, anemometro.emometer.

Equipaggiamento opzionale

Kit potenza per braccio base	Costituito da max. 3 ulteriori elementi del braccio (2 del braccio base, 1 del falcone); È richiesto un braccio base standard di 96 m.
Sistema Superlift di serie	Albero secondario 40,5 m (tipo 2322), telaio contrappeso per max. 450 t. Raggi Superlift 15 m, 18 m, 21 m, 24 m.
Superlift variabile equipaggiamento	Albero secondario 40,5 m (tipo 2322), telaio contrappeso per max 450 t. Raggio Superlift con regolazione continua durante il funzionamento da 15 a 24 m. Cilindro verticale e sistema di stabilizzazione per contrappeso Superlift.
Superlift con contrappeso carro	Albero 40,5 m (tipo 2322), contrappeso carro per max. 450 t. Raggio superlift con regolazione continua durante il funzionamento da 18 a 24 m.
Argano H3	Ulteriore tamburo su braccio base (per LF o per l'uso del runner). Tiro come H1, lunghezza fune 700 m.
Runner 46 t	Circa 2 m per installazione su testa braccio o elemento superiore.
Protezione anticaduta	Sistema di protezione anticaduta per braccio base, falcone e albero Superlift.

Chasis de orugas

	Chasis de 3 secciones, formado por un cuerpo central con estabilizadores plegados para el transporte y dos orugas. La conexión con pernos hidráulicos entre las orugas y el cuerpo central aseguran un fácil montaje y desmontaje, reduciendo al mínimo la anchura y el peso para su transporte.
Parte central	Estructura soldada resistente a la flexión y a la torsión, fabricada con acero de construcción de grano fino y alta resistencia.
Bastidores laterales de las orugas	Estructura soldada resistente a la flexión, fabricada con acero de construcción de grano fino y alta resistencia. Lubricación centralizada incluida de serie.
Orugas	15 rodillos por cada oruga con superficies de rodadura endurecidas. Posición elevada para los piñones de transmisión y las ruedas intermedias, los cuales proporcionan capacidad de soporte de carga para elevación; tensión de oruga regulable. Cada oruga es controlada en progresión continua, tanto independientemente como en direcciones opuestas.
Tren de transmisión	Las orugas están propulsadas por dos motores hidráulicos, cada uno de ellos con engranajes planetarios en cárter cerrado y baño de aceite, equipadas con frenos de parada accionados por muelle y soldados hidráulicamente. Los engranajes tienen un diseño extremadamente compacto para caber dentro de la anchura de las orugas. Cada oruga es controlada en progresión continua, tanto independientemente como en direcciones opuestas. Transmisión Quadro de serie.
Lastre central	80 t.

Superestructura

Contrapesos	250 t.
Bastidor	Estructura soldada resistente a la flexión y a la torsión, fabricada con acero de construcción de grano fino y alta resistencia.
Tracción	Dos motores diésel MTU de 6 cilindros refrigerados por agua, con funcionamiento redundante, tipo OM 460 LA, 2 x 315 kW (428 CV) a 1800 rpm. El motor cumple con las normativas EUROMOT 3b, Tier 4i y CARB. Capacidad del depósito de combustible: 1500 l.
Tambores de cable	El equipamiento de serie de la superestructura incluye tres tambores de cable: cabestrante 1, cabestrante 2 y cabestrante de pluma. Los tambores son accionados por motores hidráulicos a través de engranajes planetarios en cárter cerrado y baño de aceite. Todos los tambores de cable tienen frenos multidisco accionados por muelle y soldados hidráulicamente, y frenado sin desgaste para reducir el peso. Los extremos de los cables H 1, 2, 3 y W 1, 2 están equipados con accesorios de conexión rápida. Los cabestrantes H1 y 2 y el caballete con cabestrante de pluma pueden desmontarse para reducir al mínimo el peso para su transporte.
Caballete	Los cilindros en la superestructura para elevar el caballete están incluidos de serie.
Mecanismo de giro	Accionado por cuatro motores hidráulicos a través de engranajes planetarios en cárter cerrado y baño de aceite. Freno de parada accionado por muelle y soldado hidráulicamente, y frenado sin desgaste.
Sistema de control	IC-1: Control piloto electrónico de válvulas proporcionales integrado en un sistema de control por programa almacenado, incluido diagnóstico. Monitores de dos colores, indicador de carga operado por pantalla táctil. Velocidades de trabajo controladas en progresión continua por la posición de la palanca. Control automático de potencia para un aprovechamiento óptimo de la potencia del motor. De serie: limitación del área de trabajo, indicador de presión sobre el terreno, así como de la carga de los estabilizadores.
Cabina	Confortable cabina con amplio parabrisas y aire acondicionado. Lunas de vidrio laminado, luna en el techo, calefacción de aire caliente autónoma, instrumentos y controles completos de la grúa. La cabina puede ser inclinada hacia atrás para mejorar la visibilidad de manejo de la pluma. Ha sido instalado un sistema de cámara para supervisar los tambores de cable. Para su transporte, la cabina gira delante de la superestructura para reducir la anchura al mínimo.
Equipamiento eléctrico	Sistema de 24 V (2 baterías de 12 V / 180 Ah).
Conexión rápida	Los accesorios hidráulicos de desconexión rápida en el chasis y en la superestructura facilitan el desmontaje para reducir al mínimo el peso para su transporte, de serie.

Equipamiento opcional

Cilindro hidráulico del caballete	Para el automontaje de orugas.
Estabilizadores laterales	Para erigir sistemas de pluma larga.
Carro de contrapeso	Peso total máx. 450 t, en combinación con el sistema telescópico SL.
Estabilizadores PC	Base de estabilizador 14 x 14 m. Como alternativa a las orugas.

¡Otras opciones a petición!

Configuraciones de pluma S y L

SH:	Pluma principal: tramo de pie 12 m, tramos intermedios 6 m, 10,5 m y 12 m (tipo 3328), cabeza de la pluma 1,5 m. Longitudes de pluma principal: 36-96 m.
SH / LH: (SGL variable)	Pluma principal: tramos de pie 12 m, tramos intermedios 6 m, 10,5 m y 12 m (tipo 3328), tramo reductor, extendida con tramos intermedios 6 m y 12 m (tipo 2822), tramo superior 7,5 m. Longitudes de pluma principal: 48-108 m.
LH:	Pluma principal: tramo de pie 12 m, tramo intermedio 10,5 m (tipo 3328), tramo reductor, extendida con tramos intermedios 6 m y 12 m (tipo 2822), tramo superior 7,5 m. Longitudes de pluma principal: 48-114 m.
SW:	Pluma principal: igual que SH. Inclinable de 87° a 65°. Plumín abatible: tramo de pie 4,5 m, tramo intermedio 12 m (tipo 3328), tramo reductor, extendido con tramo intermedio 6 m y tramos intermedios 12 m (tipo 2822), tramo superior 7,5 m. Longitudes de pluma principal: 42-60 m. Longitudes de plumín: 30-96 m.
SSL:	Pluma principal: igual que SH. Equipamiento Superlift. Longitudes de pluma principal: 42-96 m.
SSL / LSL: (SGL 94,5 m)	Pluma principal: tramo de pie 12 m, tramos intermedios 6 m, 10,5 m y 12 m (tipo 2822), tramo reductor, extendido con tramos intermedios 6 m y 12 m (tipo 2822), tramo superior 7,5 m. Equipamiento Superlift. Longitudes de pluma principal: 102-150 m.
SSL / LSL S1:	Pluma principal: igual que SSL, extensión con kit de refuerzo de pluma + tramo superior de plumín. Longitudes de pluma principal: 66-156 m.
SWSL / SFSL:	Pluma principal: igual que SH. Inclinable de 87° a 45°. Plumín abatible: igual que SW. Equipamiento Superlift. Longitudes de pluma principal: 48-96 m. Longitudes de plumín: 30-108 m.
SFVL:	Pluma principal: igual que SH. Equipamiento Superlift. Extensión rígida: tramo de pie 4,5 m, tramo intermedio 12 m (tipo 3328), cabeza SFVL adicional incluida. Longitudes de pluma principal: 48-72 m. Longitud de plumín: 18 m.
LFVL:	Pluma principal: igual que SH. Equipamiento Superlift. Extensión rígida: tramo de pie 4,5 m, tramo reductor, parte superior 7,5 m. Longitudes de pluma principal: 48-96 m. Longitud de plumín: 18 m.
+LF:	Adicionalmente a la configuración de pluma principal SH, SSL, SH/LH, SSL/LSL, SSL/LSL S1. Longitudes de plumín: 15 m, 21 m, 27 m, 33 m. Ángulos de plumín: 15°, 20°, 30°. Runner en LF máx. 24 t de serie.
Fijación de la pluma	Fijación de tramos de pluma por pernos asistidos hidráulicamente de serie.
Cabestrante pasador	Montado en la superestructura.
Dispositivos de seguridad	Indicador electrónico de carga, interruptor de límite de elevación para movimientos de pluma, retén hidráulico de pluma, anemómetro.

Equipamiento opcional

Kit de refuerzo para la pluma principal	Consistente en máx. 3 tramos de pluma adicionales (2 de pluma principal, 1 de plumín); la pluma principal estándar requiere 96 m.
Equipamiento Superlift de serie	Mástil 40,5 m (tipo 2322), bandeja de contrapeso para máx. 450 t. Radios de Superlift 15 m, 18 m, 21 m, 24 m.
Superlift variable equipamiento	Mástil 40,5 m (tipo 2322), bandeja de contrapeso para máx. 450 t. Radio de Superlift en progresión continua durante la operación de 15 a 24 m. Cilindro vertical y sistema estabilizador para contrapeso Superlift.
Superlift con carro de contrapeso	Mástil 40,5 m (tipo 2322), carro de contrapeso para máx. 450 t. Radio de superlift en progresión continua durante la operación de 18 a 24 m.
Cabestrante H3	Tambor de cable adicional en pluma principal (para operación de LF o runner). Tiro de cable igual que H1, longitud de cable 700 m.
Runner 46 t	Aprox. 2 m para instalación en la cabeza de pluma o tramo superior.
Protección contra caídas	Sistema de protección contra caídas para pluma principal, plumín y mástil Superlift.

Veículo sobre esteiras

	Veículo de 3 seções formado pelo chassi com estabilizadores retráteis para transporte e duas esteiras. Conexões por pinos hidráulicos entre as esteiras e o chassi facilitam a instalação e a retirada, diminuindo a largura e o peso para o transporte.
Base de giro central	Estrutura soldada resistente a flexão e torção fabricada com aço estrutural de granulação fina e alta resistência.
Estruturas laterais das esteiras	Estrutura soldada resistente à flexão fabricada com aço estrutural de granulação fina e alta resistência. Lubrificação centralizada incluída como item de série.
Esteiras	Esteiras de 15 roletes com superfícies cementadas. Posição elevada das engrenagens motoras e das rodas livres, todas com retesamento das esteiras ajustável para a capacidade de carga no içamento. Cada esteira tem controle de variação infinita, tanto em modo independente quanto em sentidos inversos.
Sistema de transmissão	As esteiras são comandadas por dois motores hidráulicos cada uma, através de caixas fechadas com engrenagens planetárias em banho de óleo, equipadas com freios de retenção com liberação hidráulica por ação de mola. As caixas têm construção bastante compacta, próprias para a largura das esteiras. Cada esteira tem controle de variação infinita, tanto em modo independente quanto em sentidos inversos. Tração quádrupla como item de série.
Lastro central	80 t.

Superestrutura

Contrapeso	250 t.
Chassi	Estrutura soldada resistente a flexão e torção fabricada com aço estrutural de granulação fina e alta resistência.
Tração	Dois motores redundantes a diesel de seis cilindros refrigerados a água MTU tipo OM 460 LA, 2 x 315 kW (428 HP) a 1800 ¹ /min. Os motores atendem aos regulamentos EUROMOT 3b, Tier 4i e CARB. Capacidade do tanque de combustível: 1500 l.
Tambores dos cabos de aço	O equipamento padrão da superestrutura inclui três tambores para cabos de aço – guincho 1, guincho 2 e guincho da lança. Os tambores são comandados por motores hidráulicos através de caixas fechadas com engrenagens planetárias em banho de óleo. Todos os tambores contam com freios multidisco de liberação hidráulica por ação de mola e frenagem hidráulica sem desgaste para a descida das cargas. Pontas dos cabos H 1, 2, 3 e W 1, 2 equipadas com conexões de engate rápido. Os guinchos H1, H2 e do suporte angular com o guincho da lança são removíveis para otimizar o peso de transporte.
Suporte angular	Os cilindros na superestrutura para elevar o suporte angular são itens de série.
Unidades de giro	Comandadas por quatro motores hidráulicos através de caixas fechadas com engrenagens planetárias em banho de óleo. Freio de retenção com liberação hidráulica por ação de mola e frenagem hidráulica sem desgaste.
Sistema de controle	IC-1: Controle eletrônico proporcional do piloto da válvula integrado ao sistema de controle por programa armazenado incluindo diagnósticos. Dois monitores coloridos, indicador de carga operado através de tela de toque. Velocidades de trabalho infinitamente variáveis, controladas pela posição da alavanca. Controle automático de potência para máxima utilização do rendimento do motor. Limitação do raio de trabalho, indicador da pressão sobre o solo e indicador de carga sobre os estabilizadores como itens de série.
Cabine	Cabine confortável com amplo parabrisa e ar condicionado. Vidro laminado em toda a volta, teto solar, aquecedor de ar autônomo, instrumentação completa e controles do guindaste. A cabine pode ser reclinada para melhorar a visão da ponta da lança pelo operador. Há um sistema de câmera instalado para monitorar os tambores dos cabos de aço. Para transporte, a cabine rebate para a frente da superestrutura a fim de diminuir a largura.
Equipamentos elétricos	Sistema de 24 V (2 baterias de 12 V / 180 Ah).
Conexão rápida	Conexões hidráulicas de desengate rápido do veículo e na superestrutura facilitam a remoção para diminuir o peso de transporte. Itens de série.

Equipamentos opcionais

Suporte angular com cilindros hidráulicos	Para automontagem das esteiras.
Estabilizadores laterais	Para montagem de sistemas de lança longa.
Veículo dos contrapesos	Peso máx. total 450 t, combinado com sistema telescópico SL.
Estabilizadores para PC	Base estabilizadora 14 x 14 m. Alternativa para as esteiras.

Outros opcionais a pedido!

Configurações de lança S e L

SH:	Lança principal: seção do pé 12 m, suplementos de 6 m, 10,5 m e 12 m (tipo 3328), cabeça da lança 1,5 m. Comprimentos da lança principal: 36-96 m.
SH / LH: (SGL variável)	Lança principal: seções do pé 12 m, suplementos de 6 m, 10,5 m e 12 m (tipo 3328), suplemento cônico, prolongado por suplementos de 6 m e 12 m (tipo 2822), seção de topo 7,5 m. Comprimentos da lança principal: 48-108 m.
LH:	Lança principal: seção do pé 12 m, suplemento 10,5 m (tipo 3328), suplemento cônico, prolongado por suplementos de 6 m e 12 m (tipo 2822), seção de topo 7,5 m. Comprimentos da lança principal: 48-114 m.
SW:	Lança principal: igual à SH. Inclinação 87° a 65°. Lança auxiliar articulada: seção do pé 4,5 m, suplemento 12 m (tipo 3328), suplemento cônico, suplemento de 6 m e suplementos de 12 m (tipo 2822), seção de topo 7,5 m. Comprimentos da lança principal: 42-60 m. Comprimentos da lança auxiliar: 30-96 m.
SSL:	Lança principal: igual à SH. Equipamento Superlift. Comprimentos da lança principal: 42-96 m.
SSL / LSL: (SGL 94,5 m)	Lança principal: seção do pé 12 m, suplementos de 6 m, 10,5 m e 12 m (tipo 2822), suplemento cônico, prolongado por suplementos de 6 m e 12 m (tipo 2822), seção de topo 7,5 m. Equipamento Superlift. Comprimentos da lança principal: 102-150 m.
SSL / LSL S1:	Lança principal: igual à SSL, alongada por kit de expansão da lança principal + seção de topo da auxiliar. Comprimentos da lança principal: 66-156 m.
SWSL / SFSL:	Lança principal: igual à SH. Inclinação 87° a 45°. Lança auxiliar articulada: igual à SW. Equipamento Superlift. Comprimentos da lança principal: 48-96 m. Comprimentos da lança auxiliar: 30-108 m.
SFVL:	Lança principal: igual à SH. Equipamento Superlift. Lança auxiliar fixa: seção do pé 4,5 m, suplemento 12 m (tipo 3328), cabeça SFVL adicional incluída. Comprimentos da lança principal: 48-72 m. Comprimento da lança auxiliar: 18 m.
LFVL:	Lança principal: igual à SH. Equipamento Superlift. Lança auxiliar fixa: seção do pé 4,5 m, complemento cônico, seção de topo 7,5 m. Comprimentos da lança principal: 48-96 m. Comprimento da lança auxiliar: 18 m.
+LF:	Em acréscimo às configurações da lança principal SH, SSL, SH/LH, SSL/LSL, SSL/LSL S1. Comprimentos da lança auxiliar: 15 m, 21 m, 27 m, 33 m. Inclinação da lança auxiliar: 15°, 20°, 30°. Ponta de montagem na LF máx. 24 t série.
Pinagem da lança	A pinagem hidráulica assistida das seções da lança é característica de série.
Guincho de passagem	Montado na superestrutura.
Equipamentos de segurança	Indicador eletrônico de carga, chave limitadora do guincho para os movimentos da lança, batentes hidráulicos da lança, anemômetro.

Equipamentos opcionais

Kit de expansão da lança principal	Consistindo de no máx. 3 seções adicionais (2 da lança principal, 1 da auxiliar); Necessária lança principal padrão de 96 m.
Equipamento Superlift de série	Mastro 40,5 m (tipo 2322), base de contrapesos para máx. 450 t. Raios do Superlift de 15 m, 18 m, 21 m, 24 m.
Superlift variável equipamento	Mastro 40,5 m (tipo 2322), base de contrapesos para máx. 450 t. Raio do Superlift infinitamente variável entre 15 e 24 m durante a operação. Cilindro vertical e sistema estabilização para contrapesos do Superlift.
Superlift com veículo dos contrapesos	Mastro 40,5 m (tipo 2322), veículo dos contrapesos para máx. 450 t. Raio do superlift infinitamente variável entre 18 e 24 m durante a operação.
Guincho H3	Tambor adicional para cabos na lança principal (para operação com LF ou runner). Tração da linha igual ao H1, comprimento do cabo 700 m.
Runner 46 t	Aprox. 2 m para instalação da cabeça da lança ou seção de topo.
Proteção contra quedas	Sistema de proteção contra quedas para a lança principal, lança auxiliar e mastro do Superlift.

Гусеничное шасси

	3-секционное шасси экскаватора, включающее корпус шасси со сложенными для транспортировки выдвижными опорами и две гусеницы. Штифтовые соединения корпуса шасси и гусениц, обслуживаемые гидравликой, обеспечивают легкость сборки и разборки для уменьшения ширины и веса при транспортировке.
Центральная коробка	Сварная конструкция из устойчивой к изгибу и кручению высокопрочной мелкозернистой конструкционной стали.
Боковые стенки шасси	Сварная конструкция из устойчивой к изгибу высокопрочной мелкозернистой конструкционной стали. Система централизованной смазки в стандартной комплектации.
Гусеницы	Катки с 15 траками с закаленной поверхностью качения. Подъем как ведущих звездочек так и неприводных колес, ведущие звездочки и неприводные колеса обеспечивают грузоподъемность необходимую для сборки, регулируемое натяжение гусениц. Бесступенчатая регулировка движения каждой гусеницы, отдельно и в противоположном направлении.
Силовая передача	Гусеничные цепи приводятся в движение двумя гидравлическими двигателями, каждый через свою планетарную передачу, вращающуюся в масляной ванне в закрытом корпусе, каждая имеет подпружиненный тормоз с гидроусилителем. Редукторы имеют исключительно компактную конструкцию и не выходят за ширину гусениц. Бесступенчатая регулировка движения каждой гусеницы, отдельно и в противоположном направлении. Квадропривод в стандартной комплектации.
Центральный балласт	80 т.

Надстройка

Противовес	250 т.
Рама	Сварная конструкция из устойчивой к изгибу и кручению высокопрочной мелкозернистой конструкционной стали.
Привод	Два дизельных 6-цилиндровых двигателя с водяным охлаждением MTU типа OM 460 LA, 2 x 315 кВт (428 л.с.) при 1800 об/мин, один из которых резервный. Двигатель соответствует требованиям стандартов EUROMOT 3b, Tier 4i и CARB. Емкость топливного бака: 1500 л.
Канатные барабаны	Стандартная комплектация оборудования надстройки включает три канатных барабана – лебедки 1, лебедки 2 и лебедки стрелы. Барабаны приводятся в движение гидравлическими двигателями через планетарную передачу, вращающуюся в масляной ванне в закрытом корпусе. Каждый канатный барабан имеет подпружиненный многодисковый тормоз с гидроусилителем и неизнашивающийся гидравлический тормоз для опускания груза. Концы тросов для лебедок H 1, 2, 3 и W 1, 2 имеют быстроразъемные соединительные концевые фитинги. Лебедки H 1 и H 2 и A-образная рама с лебедкой стрелы съемные для уменьшения веса при перевозке.
A-образная рама	A-образная рама поднимается при помощи цилиндров, установленных на надстройке, входящих в стандартную комплектацию.
Узлы поворотных механизмов	Приводятся в движение четырьмя гидравлическими двигателями через планетарную передачу, вращающуюся в масляной ванне в закрытом корпусе. Подпружиненный тормоз с гидроусилителем и неизнашивающийся гидравлический тормоз.
Система управления	IS-1: Заложена в установленную программу управления, включающую диагностику, система электронного пропорционального управления через регулирующие клапаны. Два цветных монитора, индикатор нагрузки, управляемый через сенсорный экран. Бесступенчатая регулировка рабочих скоростей изменением положения рычага. Автоматическая регулировка мощности для оптимизации выходной мощности двигателя. Ограничитель рабочего диапазона, индикатор давления на грунт и индикатор нагрузки на опоры в стандартной комплектации.
Кабина	Комфортабельная кабина с большим ветровым стеклом и кондиционером. Все остекление из ламинированного стекла, потолочный люк, отдельный воздушный обогреватель, полный комплект приборов и органов управления краном. Кабина откидывается назад для лучшего обзора конца стрелы крана. Для управления канатными барабанами установлена система камер. Для транспортировки кабина разворачивается и устанавливается перед надстройкой, чтобы уменьшить ширину.
Электрическое оборудование	Система с напряжением 24 В (2 аккумулятора 12 В/180 А-ч).
Быстроразъемное соединение	Система гидравлических быстроразъемных фитингов на шасси и надстройке, облегчающих разборку для снижения веса при перевозке, в стандартной комплектации.

Дополнительное оборудование

A-образная рама с гидравлическим цилиндром	Для самосборки гусениц.
Боковые выдвижные опоры	Для сборки систем с длинной стрелой.
Платформа для перевозки противовесов	Общий вес максимум 450 т вместе с системой телескопической стрелы SL.
Выдвижные опоры для сборки в версии пьедестального крана	Площадь опоры выдвижных опор 14 x 14 м. Как альтернатива может использоваться опора на гусеницы.

Дополнительные опции на заказ!

Варианты конфигурации стрел S и L

SH:	Главная стрела: нижняя секция 12 м, вставки 6 м, 10,5 м и 12 м (тип 3328), головка стрелы 1,5 м. Главная стрела: 36-96 м.
SH / LH: (стрела SGL переменной длины)	Главная стрела: нижняя секция 12 м, вставки 6 м, 10,5 м и 12 м (тип 3328), сужающаяся вставка, удлиненная вставками 6 м и 12 м (тип 2822), верхняя секция 7,5 м. Главная стрела: 48-108 м.
LH:	Главная стрела: нижняя секция 12 м, вставка 10,5 м (тип 3328), сужающаяся вставка, удлиненная вставками 6 м и 12 м (тип 2822), верхняя секция 7,5 м. Главная стрела: 48-114 м.
SW:	Главная стрела: идентична SH. Угол смещения 87°-65°. Стрела с изменяемым вылетом и гуськом нижняя секция 4,5 м, вставка 12 м (тип 3328), сужающаяся вставка, вставки 6 м и 12 м (тип 2822), верхняя секция 7,5 м. Главная стрела: 42-60 м. Длина вылета стрелы с изменяемым вылетом: 30-96 м.
SSL:	Главная стрела: идентична SH. Оборудование суперлифт. Главная стрела: 42-96 м.
SSL / LSL: (SGL 94.5 м)	Главная стрела: нижняя секция 12 м, вставки 6 м, 10,5 м и 12 м (тип 2822), сужающаяся вставка, удлиненная вставками 6 м и 12 м (тип 2822), верхняя секция 7,5 м. Оборудование суперлифт. Главная стрела: 102-150 м.
SSL / LSL S1:	Главная стрела: идентична SSL, удлиненной за счет комплекта boom power-kit+ верхней секции стрелы. Главная стрела: 66-156 м.
SWSL / SFSL:	Главная стрела: идентична SH. Угол смещения 87°-45°. Стрела с изменяемым вылетом и гуськом идентична SW. Оборудование суперлифт. Главная стрела: 48-96 м. Длина вылета стрелы с изменяемым вылетом: 30-108 м.
SFVL:	Главная стрела: идентична SH. Оборудование суперлифт. Неподвижная стрела: нижняя секция 4,5 м, вставка 12 м (тип 3328), включает дополнительную головку SFVL. Главная стрела: 48-72 м. Длина вылета стрелы с изменяемым вылетом: 18 м.
LFVL:	Главная стрела: идентична SH. Оборудование суперлифт. Неподвижная стрела: нижняя секция 4,5 м, сужающаяся вставка, верхняя секция 7,5 м. Главная стрела: 48-96 м. Длина вылета стрелы с изменяемым вылетом: 18 м.
+LF:	в дополнение к конфигурации главной стрелы SH, SSL, SH/LH, SSL/LSL, SSL/LSL S1. Длина вылета стрелы с изменяемым вылетом: 15 м, 21 м, 27 м, 33 м. Угол смещения стрелы с изменяемым вылетом: 15°, 20°, 30°. Подвижной блок на LF максимум 24 т в стандартной комплектации.
Соединение штифтами стрелы	Гидравлическая система соединения штифтами секций стрелы входит в стандартную комплектацию.
Запасовочная лебедка	Установлена на надстройке.
Вспомогательные приборы управления	Электронный индикатор нагрузки, концевой выключатель ограничителя движения стрелы, гидравлические ограничители обратного хода стрелы, анемометр.

Дополнительное оборудование

Комплект Power-kit для главной стрелы	Включающий максимально 3 дополнительные секции (2 главной стрелы, 1 дополнительной стрелы); Обязательное условие – наличие главной стрелы длиной 96 м.
Стандартный комплект оборудования суперлифт	Мачта 40,5 м (тип 2322), платформа для противовесов на максимальный вес 450 т. Рабочий радиус комплекта оборудования суперлифт 15 м, 18 м, 21 м, 24 м.
Оборудование суперлифт с регулировкой по весу подъема	Мачта 40,5 м (тип 2322), платформа для противовесов на максимальный вес 450 т. Бесступенчатая регулировка радиуса суперлифт в процессе подъема в диапазоне 15-24 м. Цилиндрвертикального подъема и система стабилизаторов для противовесов системы суперлифт.
Система суперлифт с тягачом и платформой для противовесов	Мачта 40,5 м (тип 2322), тягач с платформой для противовесов на максимальный вес 450 т. Бесступенчатая регулировка радиуса суперлифт в процессе подъема в диапазоне 18-24 м.
Лебедка НЗ	Дополнительный канатный барабан на главной стреле (для стрелы LF или подвижного блока). Тяговое усилие на тросе то же, что и для лебедки Н1, длина троса 700 м.
Подвижной блок на 46 т	Прибл. 2 м для установки на головке стрелы или верхней секции.
Защита от падения с высоты	Защита от падения с высоты на главной стреле, стреле с изменяемым вылетом и мачте суперлифт.

Anmerkungen zu den Tragfähigkeiten · Conditions d'utilisation · Annotazioni sulle portate · Condiciones de utilización · Notas sobre capacidade de içamento · Примечания по грузоподъемности

Ratings are in compliance with ISO 4305.

Weight of hook blocks and slings is part of the load, and is to be deducted from the capacity ratings.

Consult operation manual for further details.

Note: Data published herein is intended as a guide only and shall not be construed to warrant applicability for lifting purposes.

Crane operation is subject to the computer charts and operation manual both supplied with the crane.

In some instances the superlift counterweight does not lift off the ground with the indicated load.

Tragfähigkeiten entsprechen ISO 4305.

Das Gewicht der Unterflaschen, sowie die Lastaufnahmemittel, sind Bestandteile der Last und sind von den Tragfähigkeitsangaben abzuziehen.

Weitere Angaben in der Bedienungsanleitung des Kranes.

Anmerkung: Die Daten dieser Broschüre dienen nur zur allgemeinen Information; für ihre Richtigkeit übernehmen wir keine Haftung. Der Betrieb des Kranes ist nur mit den Original-Tragfähigkeitstabellen und mit der Bedienungsanleitung zulässig, die mit dem Kran mitgeliefert werden.

In einigen Fällen hebt das Superliftgegengewicht bei den angegebenen Traglasten nicht ab.

Le tableau de charges est conforme à la norme ISO 4305.

Les poids du crochet-moufle et de tous les accessoires d'élingage font partie de la charge et sont à déduire des charges indiquées.

Pour plus de détails consulter la notice d'utilisation de la grue.

Nota: Les renseignements ci-inclus sont donnés à titre indicatif et ne représentent aucune garantie d'utilisation pour les opérations de levage. La mise en service de la grue n'est autorisée qu'à condition que les tableaux de charges ainsi que le manuel de service, tels que fournis avec la grue, soient observés.

Le contrepoids du superlift ne décolle pas dans certaines configurations des tableaux de charge.

Le portate sono conformi alla norma ISO 4305.

Il peso del bozzello e delle funi d'attacco fanno parte del carico e sono quindi da detrarre dai valori di tabella.

Per ulteriori dettagli sulla velocità vento, consultare il manuale di istruzione della gru.

Nota: I dati riportati su tale prospetto sono solo a titolo indicativo e pertanto non impegnativi. L'impiego della gru è ammesso solo rispettando le tabelle originali ed il manuale di uso fornito assieme alla gru.

In alcuni casi, con il carico indicato, il contrappeso Superlift non si solleva dal suolo.

Las capacidades de carga están sujetas a las normas ISO 4305.

El peso de los ganchos y eslingas son parte de la carga y serán deducidos de las capacidades brutas.

Consultar los manuales de operación para ampliar información.

Observación: Los datos publicados son solamente orientativos y no se deben interpretar como garantía de aplicación para determinadas operaciones de elevación. La manipulación de la grúa está sujeta a las cargas programadas en el ordenador y en el manual de operaciones, ambos suministrados con la grúa.

En algunos casos, el contrapeso superlift no se eleva del suelo con la carga indicada.

Valores nominais de acordo com a ISO 4305.

O peso dos moitões e eslingas faz parte da carga e tem de ser subtraído das capacidades nominais.

Consultar manual de operação para outros detalhes.

Nota: Os dados publicados aqui destinam-se a simples orientação e não devem ser interpretados como garantia de aplicabilidade para fins de içamento. A operação da grua depende de tabelas de computador e do manual de operação, ambos fornecidos com a máquina.

Em alguns casos, o contrapeso do Superlift não levanta do solo com a carga indicada.

Номинальные значения соответствуют ISO 4305.

Вес крюкоблока и строп является частью груза и должен вычитаться из номинальных значений грузоподъемности.

Подробности см. в руководстве по эксплуатации.

Примечание. Публикуемые в настоящем издании данные приводятся только для справки и не должны использоваться при расчете нагрузки. При эксплуатации крана должны применяться компьютерные таблицы и руководство по эксплуатации, входящие в комплект поставки крана.

В некоторых случаях противовес системы суперлифт не может быть поднят с земли с указанной нагрузкой.

NOTES

CC 6800

Notizen · Notes · Nota · Notas · Notas ·
пометы, комментарии, примечания

A large rectangular area with horizontal lines, intended for writing notes. The lines are evenly spaced and cover the majority of the page's width and height.

www.terexcranes.com

Effective Date: September 2011.

Product specifications and prices are subject to change without notice or obligation. The photographs and/or drawings in this document are for illustrative purposes only. Refer to the appropriate Operator's Manual for instructions on the proper use of this equipment. Failure to follow the appropriate Operator's Manual when using our equipment or to otherwise act irresponsibly may result in serious injury or death. The only warranty applicable to our equipment is the standard written warranty applicable to the particular product and sale and Terex makes no other warranty, express or implied. Products and services listed may be trademarks, service marks or trade-names of Terex Corporation and/or its subsidiaries in the USA and other countries. All rights are reserved. Terex® is a registered trademark of Terex Corporation in the USA and many other countries.

Gültig ab: September 2011.

Produktbeschreibungen und Preise können jederzeit und ohne Verpflichtung zur Ankündigung geändert werden. Die in diesem Dokument enthaltenen Fotos und/oder Zeichnungen dienen rein anschaulichen Zwecken. Anweisungen zur ordnungsgemäßen Verwendung dieser Ausrüstung entnehmen Sie bitte dem zugehörigen Betriebshandbuch. Nichtbefolgung des Betriebshandbuchs bei der Verwendung unserer Produkte oder anderweitig fahrlässiges Verhalten kann zu schwerwiegenden Verletzungen oder Tod führen. Für dieses Produkt wird ausschließlich die entsprechende, schriftlich niedergelegte Standardgarantie gewährt. Terex leistet keinerlei darüber hinaus gehende Garantie, weder ausdrücklich noch stillschweigend. Die Bezeichnungen der aufgeführten Produkte und Leistungen sind gegebenenfalls Marken, Servicemarken oder Handelsnamen der Terex Corporation und/oder ihrer Tochtergesellschaften in den USA und anderen Ländern. Alle Rechte vorbehalten. „TEREX“ ist eine eingetragene Marke der Terex Corporation in den USA und vielen anderen Ländern.

Date d'effet : Septembre 2011.

Les spécifications et prix des produits sont sujets à modification sans avis ou obligation. Les photographies et/ou dessins contenus dans ce documents sont uniquement pour illustration. Veuillez vous référer à la notice d'utilisation appropriée pour les instructions quant à l'utilisation correcte de cet équipement. Tout manquement au suivi de la notice d'utilisation appropriée lors de l'utilisation de notre équipement ou tout acte autrement irresponsable peut résulter en blessure corporelle sérieuse ou mortelle. La seule garantie applicable à notre équipement est la garantie standard écrite applicable à un produit et à une vente spécifique. Terex n'offre aucune autre garantie, expresse ou implicite. Les produits et services proposés peuvent être des marques de fabrique, des marques de service ou des appellations commerciales de Terex Corporation et/ou ses filiales aux Etats Unis et dans les autres pays, et tous les droits sont réservés. «TEREX» est une marque déposée de Terex Corporation aux Etats Unis et dans de nombreux autres pays.

Data di inizio validità: Settembre 2011.

Ci riserviamo il diritto di modificare le specifiche e i prezzi dei prodotti in ogni momento e senza preavviso. Le fotografie e/o i disegni contenuti in questo documento sono destinati unicamente a scopi illustrativi. Consultare le istruzioni sull'uso corretto di questo macchinario, contenute nell'opportuno Manuale dell'operatore. L'inottemperanza delle istruzioni contenute nel Manuale dell'operatore del macchinario e altri comportamenti irresponsabili possono provocare gravi lesioni, anche mortali. L'unica garanzia applicabile ai nostri macchinari è la garanzia scritta standard applicabile al particolare prodotto e alla particolare vendita; Terex è esonerata dal fornire qualsiasi altra garanzia, esplicita o implicita. I prodotti e servizi elencati possono essere dei marchi di fabbrica, marchi di servizio o nomi commerciali di TEREX Corporation e/o società affiliate negli Stati Uniti d'America e altre nazioni e tutti i diritti sono riservati. „TEREX“ è un marchio registrato di Terex Corporation negli USA e molti altri Paesi.

Fecha efectiva: Septiembre 2011.

Los precios y las especificaciones de productos pueden sufrir cambios sin aviso previo u obligación. Las fotografías o dibujos de este documento tienen un fin meramente ilustrativo. Consulte el manual de instrucciones del operador correspondiente para más información sobre el uso correcto de este equipo. El hecho de no respetar el manual del operador correspondiente al utilizar el equipo o actuar de forma irresponsable puede suponer lesiones graves o fatales. La única garantía aplicable a nuestro equipo es la garantía escrita estándar correspondiente a cada producto y venta, y TEREX no amplía dicha garantía de forma expresa o implícita. Los productos y servicios mencionados pueden ser marcas registradas, marcas de servicio o nombres de marca de TEREX Corporation o de sus filiales en Estados Unidos de América y otros países, y se reservan todos los derechos. „TEREX“ es una marca comercial registrada de Terex Corporation en Estados Unidos de América y muchos otros países.

Data de vigência: Setembro 2011.

Especificações e preços dos produtos sujeitos a alteração sem aviso prévio ou obrigações. As fotografias e/ou desenhos deste documento servem apenas para fins ilustrativos. Consulte o respectivo Manual de Instruções para instruções sobre o uso correto deste equipamento. A falta de atenção ao respectivo Manual do Operador no uso de nosso equipamento ou a operação da máquina em condições impróprias pode resultar em lesão grave ou morte. A única garantia aplicável aos nossos equipamentos é a garantia padrão por escrito, aplicável ao produto específico e à sua venda, sem que nenhuma outra, expressa ou implícita, seja oferecida pela Terex. Os produtos e serviços listados podem ser marcas comerciais, marcas de serviço ou nomes-fantasia da Terex Corporation e/ou suas subsidiárias nos EUA e em outros países. Todos os direitos reservados. Terex® é marca registrada da Terex Corporation nos EUA e muitos outros países.

Вступает в силу: Сентябрь 2011 г.

Технические характеристики и цены могут изменяться без предварительного уведомления и без каких-либо обязательств для производителя. Фотографии и (или) чертежи, использованные в документе, приведены исключительно в качестве иллюстраций. Инструкции по правилам эксплуатации даются в соответствующих руководствах для операторов данного оборудования. Невыполнение рекомендаций руководства по эксплуатации нашего оборудования или другие безответственные действия могут повлечь серьезные травмы или смерть. Единственной гарантией, действующей в отношении нашего оборудования, является стандартная форма письменной гарантии на данный тип оборудования и на условия его продажи.

Copyright 2011 Terex Corporation

Terex Cranes, Global Marketing, Dinglerstraße 24, 66482 Zweibrücken, Germany
Tel. +49 (0) 6332 830, Email: info.cranes@terex.com, www.terexcranes.com

Brochure Reference: TC-DS-M-E/F/G/I/S/P/R-CC 6800-09/11



WORKS FOR YOU.™